

Hardware Manual

TSD80-06, TSD80-10, TSD80-15, TSD130-10, Revisions 6



Keep all manuals belonging to this product during its life span. Pass all manuals to future owners and users of this product. This English version is the original version of the product manual.

Document HWTSD80-TSD130_6_HardwareManual_EP
Version 003, 2026-04-15
Source Q:\doc\Hardware\HWTSD\TSD80-TSD130\Rev6\HWTSD80-TSD130_HardwareManual\
Destination T:\doc\Hardware
Owner re

Table of Contents

- 1 General.....6
 - 1.1 Target Group.....6
 - 1.2 Standards Used.....7
 - 1.3 Symbols Used.....7

- 2 Safety.....8
 - 2.1 Intended use.....9
 - 2.1.1 Cabinet.....9
 - 2.1.2 Power supply.....9
 - 2.1.3 Motors.....9
 - 2.1.4 Safety.....9
 - 2.2 Prohibited Use.....9
 - 2.3 Responsibility.....10
 - 2.4 EC Declaration of Conformity.....10
 - 2.5 Hazardous Materials.....10

- 3 Nomenclature.....11
 - 3.1 Order Key Codes.....11
 - 3.1.1 DCV.....11
 - 3.1.2 A_{RMS}.....11
 - 3.1.3 Fieldbus.....12
 - 3.1.4 Commutation Speed.....12
 - 3.1.5 Option Modules.....12
 - 3.2 Accessories.....12

- 4 Handling.....13
 - 4.1 Nameplate.....13
 - 4.2 Transport.....13
 - 4.3 Storage.....14
 - 4.4 Packaging.....14
 - 4.5 Disassembling.....15
 - 4.6 Maintenance, Cleaning and Repair.....15
 - 4.6.1 Cleaning.....15
 - 4.6.2 Repair.....15
 - 4.7 Disposal.....15

- 5 Technical Description.....16
 - 5.1 Features.....16
 - 5.1.1 General.....16
 - 5.1.2 Supervision.....16
 - 5.1.3 Commissioning and Diagnostics.....16

5.1.4	Communication.....	17
5.1.5	In-Drive TAMA Programming.....	17
5.1.6	PC Programming.....	17
5.2	Electrical Specifications.....	18
5.2.1	Drive.....	18
5.2.2	Rated Currents.....	19
5.3	EMC and Motor Properties.....	20
5.3.1	Protective Earthing Conductor Current.....	20
5.3.2	Motor Integrated Sensors.....	20
5.3.3	Motor Overload and Overtemperature Protection.....	21
5.4	Motor Brake.....	22
5.5	Dynamic Braking.....	22
5.6	Safety Function STO.....	23
5.6.1	Typical Use.....	23
5.6.2	Commissioning.....	23
5.6.3	Functional Description.....	23
5.6.4	Safety Characteristic Data.....	25
5.6.5	Prohibited Use.....	25
5.7	Commutation Frequency Limitation.....	26
5.7.1	Rotational Motor.....	26
5.7.2	Linear Motor.....	26
5.7.3	DC Motor.....	26
5.8	Mechanical Specifications.....	27
5.9	Ambient and Mounting Conditions.....	27
6	Mechanical Installation.....	28
6.1	Safety Instructions.....	28
6.2	Guide to Mechanical Installation.....	29
6.2.1	Drawing.....	29
6.2.2	Site.....	29
6.2.3	Cooling.....	30
6.2.4	Mounting.....	30
7	Electrical Installation.....	31
7.1	Safety Instructions.....	31
7.2	Guide to Electrical Installation.....	33
7.2.1	Connectors and Cables.....	33
7.2.2	Grounding.....	33
7.2.3	Wiring and Shielding.....	33
7.2.4	Final Check.....	33
7.3	Overview of Servo Drive Connections.....	34
7.4	Connectors and Terminals.....	35
7.5	Electrical Supplies (X1, X2).....	36
7.5.1	DC-Bus (X1).....	36

- 7.5.2 24V Logic Supply (X2).....37
- 7.6 Safe Function Outputs (X3).....39
- 7.7 Safe Torque Off STO (X4).....41
- 7.8 Fieldbus Connection (X5, X6).....43
 - 7.8.1 Tria-Link.....43
 - 7.8.2 EtherCAT.....43
- 7.9 Option Modules (X10, X11).....45
- 7.10 Encoder (X20, X21).....46
 - 7.10.1 Analog sin/cos Encoder with Index.....47
 - 7.10.2 Digital Encoder with sin/cos Signals.....48
 - 7.10.3 Digital Encoder without sin/cos Signals.....49
 - 7.10.4 Incremental RS422 Encoder with Index.....50
 - 7.10.5 Incremental RS422 Fast Encoder with Index.....51
 - 7.10.6 Incremental TTL Encoder with Index.....52
 - 7.10.7 TTL Inputs Connection.....53
- 7.11 Digital Inputs and Outputs (X30, X31).....54
 - 7.11.1 Digital Inputs.....54
 - 7.11.2 Digital Outputs.....55
- 7.12 Motor Connection (X40, X41).....57
 - 7.12.1 Motor Power Connection.....57
 - 7.12.2 Motor Temperature and Brake Output (X40.2, X41.2).....60
- 8 Commissioning and Diagnostics.....62
 - 8.1 Status Indicators.....62
 - 8.1.1 System Status Indicator.....63
 - 8.1.2 STO Status.....63
 - 8.1.3 Run and Error Link Status.....64
 - 8.1.4 Axis Status Indicator.....64
- 9 Appendix.....65
 - 9.1 Warranty Information.....65
 - 9.2 Service.....65
- References.....66
- Glossary.....67
- Revision History.....68



During operation there are hazards, with the possibility of death, serious injury or material damage. The operator must ensure that the safety instructions in this manual are followed and that all personnel responsible for working with the servo drive have read and understood the product manual.



1 General

Dear user!

This manual describes the *TSD80/TSD130* series of *Triamec* servo drives. In order to start operation of your drive quickly and without problems, read this manual before carrying out any operation with the *Triamec* hardware.

Technical data, dimensional drawings and more information can be found at www.triamec.com.

1.1 Target Group

This manual addresses persons with the following qualifications:

Transport: Only persons which know how to handle electrostatically sensitive components.

Installation: Only electrically qualified personnel.



Setup: Only persons with electrical engineering and servo drive technology qualifications.
The qualified personnel must know and observe the following standards:
IEC 60364 and IEC 60664 national accident prevention regulations.

1.2 Standards Used

Standard	Content
ISO 13849-1:2023	Safety of machinery: Safety-related parts of control systems
IEC 60204	Safety of machinery: Electrical equipment of machines
IEC 60364	Low-voltage electrical installations
IEC 60529:2013	Degrees of protection provided by enclosures (IP Code)
IEC 60664-1:2020	Insulation coordination for equipment within low-voltage systems
IEC 60721-3-2:2018 IEC 60721-3-3:2019	Classification of environmental conditions
IEC 61326-3-1:2017	Immunity Requirements for safety-related systems
IEC 61508:2010	Functional safety of electrical/ electronic/ programmable electronic safety-related systems
IEC 61800 IEC 61800-1:2021 IEC 61800-3:2022 IEC 61800-5-1:2022 IEC 61800-5-2:2016	Adjustable speed electrical power servo drive systems General Requirements EMC requirements and specific test methods Safety requirements – Electrical, thermal and energy Functional Safety

1.3 Symbols Used





The following table lists the symbols that are used in this manual. Each symbol belongs to its danger class with the risk which arises when not complying the safety instruction.

Symbol	Indication
	DANGER CAUSED BY HIGH VOLTAGE OR HIGH CURRENT! Indicates an electrical hazard situation which will result in death or serious injury, if not avoided!
	DANGER CAUSED BY ROTATING OR MOVING PARTS! Indicates a hazard situation which could result in death or serious injury, if not avoided!
	ATTENTION! Indicates a hazard situation which could result in minor or moderate injury or may cause damage to or malfunction of the hardware, if not avoided!

Notice: Indicates useful information or a reference to another document

2 Safety

- Notice:** The user must have read and understood this manual before carrying out any operation on *Triamec* hardware. The safety information must be observed every time to avoid hazards and/or material damage. *Triamec Motion AG* disclaims all responsibility to possible industrial accidents and material damages if the procedures & safety instructions described in this manual are not followed.
- Notice:** Check the Hardware Revision Number of the product. This revision number must match the Hardware Revision Number on the cover page of this manual. Always comply with the connection conditions and technical specifications.
- Notice:** Do not touch electronic components and contacts of the servo drive (electrostatic discharge may destroy components). Discharge your body before touching the servo drive.
- Notice:** Please contact *Triamec Motion AG* in case of missing information or doubt regarding the installation procedures, safety or any other issue.

Safety Information	
	During operation there are hazards, with the possibility of death, serious injury or material damage. Do not open or touch the equipment during operation. Keep all covers and cabinet doors closed during operation. Touching the equipment is allowed during installation and commissioning for properly qualified persons only.
	There is a danger of electrical arcing to electrical contacts or persons. To avoid electric arcing, never touch contacts of the servo drive or connect/disconnect the servo drive while it is operating and the power source is on.
	Contacts and cables can carry a high voltage, even when the motor is not in motion. Disconnect the servo drive from all voltage sources before it is disassembled for servicing. After shutting off the power and disconnecting the servo drive from the power lines, wait at least ten minutes before touching parts of the equipment that are normally loaded with electrical charges. Capacitors can still have dangerous voltages present up to five minutes after switching off the power. To be sure, measure the voltage of the DC Bus and wait until the voltage is below 40V.
	Only properly qualified personnel are permitted to carry out activities such as transport, installation, commissioning and maintenance. Properly qualified persons are those who are familiar with the transport, assembly, installation, commissioning and operation of the product, and who have the appropriate qualifications for their job. The qualified personnel must know and observe the following standards: <ul style="list-style-type: none"> • IEC 60364 and IEC 60664 • national accident prevention regulations
	The manufacturer of the machine must produce a risk assessment for the machine and take appropriate measures to ensure that unforeseen movements do not result in personal injury or material damage.

2.1 Intended use

Servo drives are safety components for installation into stationary electric, industrial machines and commercial systems.

Safety Information	
	<p>The manufacturer of the machine must produce a risk assessment for the machine and take appropriate measures to ensure that unforeseen movements do not result in personal injury or material damage.</p>

2.1.1 Cabinet

The servo drive must only be operated in a closed control cabinet, as defined in chapter 5.9, which may also require ventilation or cooling.

2.1.2 Power supply

The servo drive must be connected to a compatible power supply. Possible devices are *Triamec TP50, TPDC50, TP80, TPDC80* for *TSD80* servo drives and *Triamec TP130, TPDC130* for *TSD130* servo drives. Connection to power supplies is described in chapter 7.5.1.

Notice: The DC-Bus power supply always must be galvanically isolated from the supply mains.

2.1.3 Motors

The *TSD80/TSD130* family of servo drives is exclusively intended for driving suitable synchronous servo-motors, asynchronous motors, voice coil and DC motors.

2.1.4 Safety

Observe the chapter 5.6 when you use the safety function STO.

2.2 Prohibited Use

Other use than described in chapter 2.1 is not intended and can lead to injured persons or damage of equipment. The use of the servo drive in the following environments is prohibited:

- potentially explosive areas (ATEX)
- environments with corrosive and/or electrically conductive acids, alkaline solutions, oils, vapors, dusts

Commissioning the servo drive is prohibited if the machine in which it was installed,

- does not meet the requirements of the EC Machinery Directive
- does not comply with the EMC Directive or with the Low Voltage Directive
- does not comply with any national directives

The control of holding brakes by these servo drives alone may not be used in applications, where personnel security is to be ensured with the brake.

2.3 Responsibility

Electronic devices are never fail-safe. The company setting up and/or operating the machine or plant is itself responsible for ensuring that the servo drive is rendered safe if the device fails.

The standard IEC 61800-5-2 'Safety of machines' stipulates safety requirements for electrical controls. They are intended for the safety of personnel and machinery as well as for maintaining the functional capability of the machine or plant concerned, and must be observed.

The function of an emergency stop system does not necessarily cut the power supply to the drive. To protect against danger, it may be more beneficial to keep individual servo drives running or to initiate specific safety sequences.

2.4 EC Declaration of Conformity

Triamec Motion AG provides EC declarations of conformity upon request to info@triamec.com.

Notice: This product can cause high-frequency interference in non industrial environments. This can require measures for interference suppression like additional external EMC filters.

Conformance with the IEC 61800 is mandatory for the supply of servo drives within the European community.

The servo drive meets the noise immunity requirements to the 2nd environmental category (industrial environment). For noise emission the servo drive meets the requirement to a product of the category C2 under certain conditions. More information can be found in chapter 5.3.

2.5 Hazardous Materials

The drives are manufactured in conformance with RoHS Directive 2011/65/EU and the delegated RoHS-Directive (EU) 2015/863. One or more exemptions per Annex III of Directive 2011/65/EU may be applicable. The chemical composition of the product may change due to environmental influences.

3 Nomenclature

Series	DCV	-	A_{RMS}	-	Variants (Fieldbus, Speed)	[-	Option Modules (Axis 0, Axis 1)	[-	SW Options (Option 1, Option 2)]]
TSD	80	-	10	-	EH	-	ENAN	-	GYXC	

Table 1: Example part number of a TSD80-10-EH-ENAN-GYXC dual-axis servo drive with 80V nominal voltage, 10Arms per axis and EtherCAT fieldbus, supporting electrical commutation frequencies $\geq 600\text{Hz}$. It has an additional encoder module on extension slot 0 and an analog input module on slot 1. The servo drive further includes the software options for gantry stage control and eccentricity compensation.

Decide from the following product variants when ordering a TSD family drive. The “D” in the family name denotes dual axis servo drives capable of driving two motors.

The first number (DCV) after the family name is the nominal DC-bus voltage rating. This manual covers the 80V and 130V products.

The 80V product is available in 6Arms, 10Arms and 15Arms versions, the 130V is available in 10Arms only.

All available products and variants with order key codes are listed on the website www.triamec.com.

3.1 Order Key Codes

3.1.1 DCV

Code	Description
80	Nominal DC-bus voltage
130	Nominal DC-bus voltage

3.1.2 A_{RMS}

Code	Description
06	Maximum rated output current of $6A_{RMS}$
10	Maximum rated output current of $10A_{RMS}$
15	Maximum rated output current of $15A_{RMS}$

3.1.3 Fieldbus

Code	Description
E	EtherCAT
T	Tria-Link

3.1.4 Commutation Speed

Code	Description
L	Simplified Export. A servo drive with this option supports electrical commutation frequencies which are fewer than 600Hz.
H	High Speed. A servo drive with this option supports electrical commutation frequencies which are equal or higher than 600Hz and is subject to export restrictions in some countries.

3.1.5 Option Modules

For more information on the different option modules, see [6]. The order number can be found as the first two letters in the title of the corresponding module.

3.2 Accessories

Triamec Motion AG delivers some useful accessories for the drives. The table below shows the most helpful items. For more information contact Triamec Motion AG or visit the Triamec homepage www.triamec.com.

	Product	Specification
Power Supplies	TP50	Input Voltage: 1x or 3x31...35V _{AC} ±10% ¹ , 50/60Hz Output Voltage: rated 50V _{DC}
	TPDC50	Input Voltage: 1x 40...50V _{DC} ±10% ¹ Output Voltage: rated 50V _{DC}
	TP80	Input Voltage: 1x or 3x44...56V _{AC} ±10% ¹ , 50/60Hz Output Voltage: rated 80V _{DC}
	TPDC80	Input Voltage: 1x 64...80V _{DC} ±10% ¹ Output Voltage: rated 80V _{DC}
	TP130	Input Voltage: 1x or 3x44...86V _{AC} ±10% ¹ , 50/60Hz Output Voltage: rated 122V _{DC}
	TPDC130	Input Voltage: 1x 100...122V _{DC} ±10% ¹ Output Voltage: rated 122V _{DC}
Servo Drive Accessories	STO-plug assembly	If STO is not to be used
	Motor-shield/screen management	Triamec shield connection clamp

¹ This 10% is calculated for mains voltage fluctuations.

4 Handling

4.1 Nameplate

The nameplate depicted below is attached to the side of the servo drive.

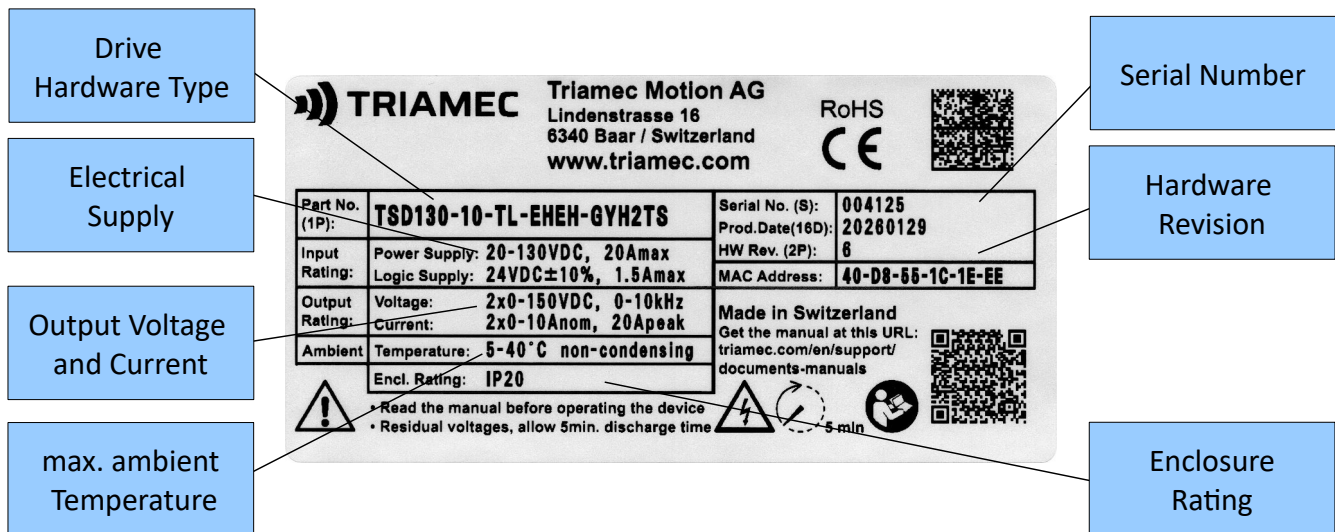

Figure 1: Nameplate of the TSD series servo drives

4.2 Transport

- During transport, the servo drive must remain inside its original packaging.
- The transport conditions must respect the IEC 61800-1 standard.
- Transport by qualified personnel only.
- Avoid shocks while transporting.
- The servo drives contain electrostatic sensitive components, that can be damaged by incorrect handling. Discharge yourself before touching the servo drive. Avoid contact with highly insulating materials, such as artificial fabrics and plastic films. Place the servo drive on a conductive surface.
- If the packaging is damaged, check the unit for visible damage. In such an event, inform the shipper and the manufacturer.

Temperature	-25°C (-13°F) and +70°C (+158°F), max. rate of change 20K / hour		
Humidity	less than 95% at max +40°C without condensation		
Shock limit	Dropping height of packed device max. 0.25m		
	Frequency	Amplitude	Acceleration
Vibration limit	2Hz ≤ f < 9Hz	3.5mm	not applicable
	9Hz ≤ f < 200Hz	not applicable	10m/s ²
	200Hz ≤ f < 500Hz	Not applicable	15m/s ²

4.3 Storage

- During storage, the servo drive must remain inside its original packaging which complies with the ESD standard.
- The storage conditions must respect the IEC 61800-1 standard.

TSD80/TSD130	
Temperature	-25°C (-13°F) and +55°C (+131°F), max. rate of change 20K / hour
Humidity	between 5 and 95% without condensation
Storage duration	Less than 2 years: without restriction. More than 2 years: capacitors must be reformed before setting up and operating the drive. To do this, remove all electrical connections and apply DC via a series resistor 220Ω / 5W for about 30 minutes to the DC-Bus terminals (X1).

4.4 Packaging

Triamec servo drives come in a recyclable cardboard box with the following content.



TSD80/TSD130	
Dimensions W x D x H	385 x 225 x 70mm ³
Labeling	label on box
Delivery content	<ul style="list-style-type: none"> ▪ Servo drive <i>TSD80</i> or <i>TSD130</i> ▪ Mating connectors X1, X2, X4, X30, X31, X40.1, X40.2, X41.1, X41.2² ▪ Sheet metal for shielding and 2 mounting screws ▪ Further documentation and installation software are available on the company website.

Accessories must be ordered separately. A list of accessories and options can be found in chapter 3.1.5.

² Mating connector X3 only if option FS is ordered.

4.5 Disassembling

Observe the sequence below, if a servo drive has to be disassembled (e.g. for replacement).

	Action
	1. Switch off the power supply that supplies the drive. Wait at least five minutes after switching off the power supply before touching potentially live sections of the equipment (e.g. contacts). To be sure, measure the voltage in the DC Bus link and wait until it has fallen below 40V. Remove the wiring. Disconnect the earth (ground) connection at last.
	2. During operation the heat sink of the servo drive may reach high temperatures. Before touching the device, check the temperature and wait until it has cooled down below 40°C (104°F).

4.6 Maintenance, Cleaning and Repair

The devices do not require any maintenance, opening the devices invalidates warranty.

4.6.1 Cleaning

If the casing is dirty, clean with Isopropanol or similar. Do not immerse or spray. Dirt inside the unit must be cleaned by the manufacturer.

4.6.2 Repair

Repair of the servo drive must be done by the manufacturer. Opening the devices means loss of the guarantee. Disassemble the equipment as described in chapter 4.5 and send it in the original packaging to Triamec Motion AG.

4.7 Disposal

We take old devices and accessories back for professional disposal (WEEE-2002/96/EC-Guidelines). Transport costs are the responsibility of the sender. Disassemble the equipment as described in chapter 4.5 and send it to Triamec Motion AG.

5 Technical Description

The Triamec digital servo drives *TSD80/TSD130* series master even the most difficult motion problems: Highly dynamic positioning tasks or on the other hand very precise motion.

This series is available for two fieldbuses, *Tria-Link* a flexible fieldbus developed by *Triamec*, and *EtherCAT*, a standardized fieldbus.

The servo drives are equipped with state of the art dual core cortex-A53 and FPGA technology that allows controller sampling rates up to 100kHz. They do not include an integral power supply. The corresponding power supplies *TP50,TPDC50, TP80,TPDC80* and *TP130,TPDC130* are ordered separately from Triamec Motion AG.

5.1 Features

5.1.1 General

- Two motor axis systems per servo drive.
- Standard two full featured encoder inputs, additional inputs possible with option modules.
- sin/cos-encoder with auto-calibration, Incremental- or digital encoder supported.
- Up to two option modules for additional encoders, analog inputs, and more.
- 100kHz current controller loop with space vector modulation and an advanced feed forward path.
- 100kHz position controller loop with dual PID architecture and 2*5 filter blocks per axis.
- 10kHz internal path planning re-programmable at 10kHz.
- External path planning at 10 kHz (axis coupling).
- Support for synchronous servomotors, asynchronous motors and direct current motors.
- Stand-alone mode, persistent parameters and program code.
- Compact dimensions.

5.1.2 Supervision

- i²t motor and drive, over-voltage, over-current protection.
- Safety function STO (up to SIL 3, Ple)
- Integrated functional safety (up to SIL 3, Ple) as option available

5.1.3 Commissioning and Diagnostics

- *TAM System Explorer* via *USB, Ethernet* or *Tria-Link*: servo drive commissioning and real time scope (80 signals at 10kHz or 8 at 100kHz).

5.1.4 Communication

- Stand-alone operation
- *Tria-Link* fieldbus with host (PC) by PCI-/PCI-Express card *TLxxx* and inter servo drive communication with up to 200Mbps.
- *EtherCAT* servo drives with standard *EtherCAT COE* slave, may be used as DC-master function.

5.1.5 In-Drive TAMA Programming

- 100µs reaction time
- Virtual Machine (TAMA) that executes freely programmable code
- possible programming languages (Microsoft® C#)
- 1 real-time user program in 10kHz task
- 1 axis coupling program in 10kHz
- 1 asynchronous user program
- Stand-alone applications possible

5.1.6 PC Programming

- Control Application on Windows PC via TAM API for Microsoft® .NET Framework
- Control Application on Beckhoff TwinCAT PLC with CNC or NCI
- Control Application on Linux PC via C++ Kernel driver

5.2 Electrical Specifications

5.2.1 Drive

		TSD80-06	TSD80-10	TSD80-15	TSD130-10	Units
DC-Bus voltage range ³		24 – 90 +2%			24 – 137.5+2%	V _{DC}
Nominal Voltage		80			130	V _{DC}
Motor Configuration		AC 2 or 3 phase synchronous or asynchronous, DC				-
Min. Motor Inductance		25			37.5	μH
Current Continuous	50 kHz	4.2 / 6 _{DC only}	10	15	10	A _{RMS}
	100 kHz	4.2 / 6 _{DC only}	7.5	12.5	7.5	A _{RMS}
Current Peak	50 kHz	6	20	30	20	A _{PK}
	100 kHz	6	20	30	20	A _{PK}
Thermal Time Constant ⁴		20				s
Switching Frequency		50 or 100				kHz
Output Power Continuous (at 50kHz)		460	1100	1650	1680	W
Logic Supply (incl. 2 Option Modules)	Voltage	24±10%				V _{DC}
	Max. Current	1.7				A
Temperature Supervision		Various sensors in the servo drive (temperature range -40°C ... 125°C), one external sensor per motor, supported sensor types: KTY83, KTY84, PT100, PT1000, PTC-1K, NTC (temperature range -40°C ... 300°C)				-
Position Encoder	General	The encoder supply is short-circuit proof and delivers 5.2V with a maximum of 1000mA for both standard encoders together. It is connected to internal 24V and requires enforced insulation against the motor phases.				-
	Analog	sin/cos 1Vpp, 65536 times interpolation, auto calibration, FIR-Filtering, max. frequency 700kHz, (software option H1/H2: 10MHz).				-
	Incremental	Glitch- and FIR-Filtering; Standards: RS-422 or TTL, RS422: max. pulse-frequency 500kHz (RS422 Fast: 10MHz), TTL: max. pulse-frequency 2.5MHz				-
	Digital	Standards: EnDat 2.1/2.2, BiSS B, BiSS C and SSI absolute pos. with analog sin/cos and EnDat 2.2, BiSS B, BiSS C, SSI, Tamagawa and Nikon without analog sin/cos.				-

³ Absolute maximum ratings.

⁴ The servo drive continuously calculates a thermal model i^2t for the three motor phases and for the three servo drive phases and switches off before damage can occur.

	TSD80-06	TSD80-10	TSD80-15	TSD130-10	Units
Digital Inputs, Safe Inputs	6 inputs per axis, ground internally connected to ground from the logic supply, 24V, In1&2(300µs), In3..6(1200µs), Inputs according to IEC EN61131-2 Type 1 with typical currents of 2.25mA@24V. Two fast inputs at Axis0 1DigIn1 (200ns).				-
Digital Inputs TTL	Up to 4 high speed inputs per axis (200ns), 5V TTL, located on the encoder connectors.				-
Digital Outputs, Safe Outputs	2 high-side and low-side switches per axis, 24V, 1A continuous. The common ground of all outputs is internally connected to the logic supply. An external supply must be provided, which may be the logic supply. Max. 2.9A continuous for all 4 outputs together. Turn-On time: Typical: 100us max. 250us; Turn-Off time: Typical: 100us max. 270us				-
Safe Function Outputs	6 Safe F-Outputs, high-side switches, 24V, 50mA. The common ground of the outputs is the 24V Logic supply ground at X2.				-
Functional Safety (FS)	Integrated Functional Safety Functions: STO, SLS, SSR, SSM, SS1, SS2, SOS, SBS, SLI, SLP, SDI				
Safe Torque Off (STO)	<p>STO inputs 1 and 2, fully isolated, 24V, inputs according to IEC EN61131-2, Type 1 with typical currents of 2.25mA@24V.</p> <p>The safe OFF-State is entered latest below $U_{Safe}^{STO} = 5V$.</p> <p>The reliable ON-State is reached above 15V.</p> <p>Process-safety time $t_{Safe}^{STO} = 50ms$, STO-inconsistent time $t_{Inconsistent}^{STO} = 160ms$</p> <p>STO-ignore time $t_{Ignore}^{STO} = 0.5ms$, STO-ignore rate $f_{Ignore}^{STO} = 1Hz$</p> <p>The STO Aux 24V output and Gnd of X4 must only be used for bridging to STO Ch1 and Ch2 of X4 when STO is not used. (see chapter 7.7)</p>				-

5.2.2 Rated Currents

The maximum permissible servo drive output current and the peak current are dependent on the power stage switching frequency, the servo drive type and the ambient temperature.

All the specifications in the table above are given for an ambient temperature ranging from +5°C (41°F) to +40°C (104°F).

Overload protection on the supply side: The TPxxx power supply hardware manual demands a three phase input current protection of 20A and a maximum prospective current rating of 40 kArms. Equivalent protection must be provided if a third party power supply is used.

5.3 EMC and Motor Properties

There are restrictions on the motor and motor cable properties depending on the PWM frequency. In the following table, capacity refers to the sum of cable capacity and motor capacity with respect to earth.

	100 kHz PWM	50 kHz PWM	Unit
Capacity per axis	10	5	nF

The Hardware Manual of the power supplies (*TP50,TPDC50, TP80,TPDC80* and *TP130,TPDC130*) contain

- Further restrictions on the total permissible capacity of all motors and motor cables attached to the same power supply.
- The expected EMC class according to the standard EN 61800-3 depending on these properties.

To reach these EMC requirements, proper shielding is mandatory, see chapter 7.2. Some motor properties might require a motor-side differential and common mode filtering. The main purpose of the differential (sine) filter is the reduction of motor ripple currents. The common mode filter attenuates displacement currents and electrical arcing between tools and conductive workpieces, and helps to improve the motor-sided EMC, especially for voice-coil and open linear motors.

If a third party power supply is used, be aware that

- The EMC level reached depends strongly on the common mode filter capability of the power supply.
- The complete system must be tested for conformance with 61800-3, especially the conducted emissions part.
- Input protection circuitry must protect the DC-Bus from external Burst and Surge events.

Safety Information	
	For insulation or voltage tests, all Triamec servo drives must be disconnected!

Notice: For more information regarding recommended grounding and shielding instructions, refer to Application Note [8].

5.3.1 Protective Earthing Conductor Current

There are two 14.1nF Y-capacitors between DC-Bus and earth. These cause currents in the protective earth connections if the DC-Bus contains common mode components of the line frequency. The same applies due to the motor shielding capacitors 5.3, when the motor PWM is on. These currents may extend beyond the 3.5mAAC limit of the 61800-5-1:2022 standard. Therefore a second earth connection is mandatory, see chapter 7.5.1.

5.3.2 Motor Integrated Sensors

Temperature sensor measurement circuit is internally connected to negative DC-Bus input. The sensor insulation has to fulfill following requirements: Functional insulation to motor phases, basic insulation



to earth and reinforced (or double) insulation to accessible conductive parts.

5.3.3 Motor Overload and Overtemperature Protection

To protect the motor from overheating, a limit value can be configured for a connected temperature sensor, see chapter 5.2.1. This drive has a current monitoring function that serves as overload protection. See Servo Drive SetupGuide [3] and following keywords: NominalCurrent, CurrentSquareTime, Type of sensor and Temperature limit.

5.4 Motor Brake

A motor holding brake can be controlled directly by the drive. The digital output 1 or 2 switch is used for the brake functionality. See brake wiring in chapter 7.11.2. Consult [3] for the software configuration of the motor brake.

Symbol	Safety Information
	AVOID DANGER ON POSSIBLE FAILURE Be aware that this is not a safety output. It is prohibited to use this output alone when failure might cause a dangerous situation.
	This function does not ensure personnel safety! Hanging loads (vertical axes) require an additional mechanical brake which must be safely operated or series connection of the safety switch in within the brake loop shown here.

Notice: A safe brake output is provided but not certified yet.

5.5 Dynamic Braking

During braking with the aid of the motor, energy is fed back to the servo drive system and the voltage of the DC-Bus may increase. Using the *Triamec TP50,TPDC50, TP80,TPDC80* or *TP130,TPDC130* supports this situation with the brake resistor in the Power supply.

Using the *Triamec TP50,TPDC50, TP80,TPDC80* or *TP130,TPDC130* power supplies, several amplifiers of the same series can be operated on a common DC bus link, without requiring any additional measures. Energy fed back by one servo drive is stored in the power supply capacitors. If the voltage passes the brake limit of the power supply, the internal or external brake resistor dissipates energy. If the energy to be dissipated goes beyond the brake resistor specification, this feature is turned off and the bridge voltage rises further. Then the maximum bridge voltage of the servo drives will be reached and the servo drives generate the error *DCBusVoltageOutOfRange* and the output stage is switched off. Since the mechanics now runs without deceleration, the bridge voltage will not rise any further. When commissioning an axis with field weakening, it must be ensured that the motor back-EMF at the maximum speed remains within the voltage limit of the servo drive. A sudden loss of the weakening current could otherwise lead to an overvoltage condition and damage the device.

For more information see the documentation of the *TP50, TP80, TP130* Power Supplies [1] and the *TPDC50, TPDC80, TPDC130* Power Supplies [2].

5.6 Safety Function STO

The Safe-Torque-Off (STO) feature protects personnel against unintended restarting of servo drives. See chapter 7.7 for connector description.

5.6.1 Typical Use

A typical use case of the STO function is the integration in the safety concept of a CNC machine. The door of the critical area contains a safety switch attached to a safety device. If the door is opened, the safety device opens two relay contacts. These are wired to the STO function of the drive. With the contacts open, the two channels of the STO cut the energy to the motor leaving the servo drive in a safe state.

5.6.2 Commissioning

Before using the *STO* safety features execute a risk assessment of the equipment to confirm that the system safety conditions are met.

The following actions need to be taken during installation before using the STO safety features.

- Make sure the *STO* channels are connected to the external safety switch as defined during parent system design.
- Setup the servo drives and start communication. Enable the axis. Make sure there is no error message.
- Disconnect one *STO* channel from the Safety switch and check the servo drive state. The state must show a *STO inconsistent error*.
- Connect both channels as standard, clear the error from above and Enable the axis again.
- Disconnect both channels simultaneously. The state must show *STO Active Error*.
- *TwinCat* users: Be aware that the system level designer might have chosen to disable direct error event reporting from the Triamec module to the user. It is at the system level designers responsibility to propagate the plc-axis errors during commissioning in this case.

Some internal tests (flash and RAM-tests) are only done during 24V start-up and after resetting an *STO* fault. Make sure any one of the following procedures is done minimum once a year:

- Turn off 24V for at least 10s or
- Generate an *STO error*, e.g., *STO-Inconsistent* (a *STO-Active warning* is not sufficient) or
- Software activation of this error is also possible, ask Triamec Motion AG for details.

5.6.3 Functional Description

The servo drives power stage may be activated only, if both *STO* channels are enabled. These channels engage the power supply of the semiconductor drivers.

Cutting any of these two channels below U_{Safe}^{STO} will deactivate the drivers and the motors do not receive any energy after a maximum time of t_{Safe}^{STO} (process safety time). This feature has priority over software and can not be disabled by software. For external diagnostic purposes, the channels may be pulsed with 0V pulses of maximum duration t_{Ignore}^{STO} at a maximum rate of f_{Ignore}^{STO} .

5.6.3.1 Standard Case

If STO is activated simultaneously on both channels as intended, the servo drive will enter a safe state:

- The warning state *Not-ReadyToSwitchOn/STO-Active* is entered when STO is activated from the switched off state *ReadyToSwitchOn*. This state is left without reset, if the STO is inactivated.
- The error state *FaultPending/STO-Active* is entered when STO is activated from the switched on state *Operational*. This state is left only with a reset command. The next state is either a warning state *Not-ReadyToSwitchOn* if a warning condition is still active (i.e., *STO-active*, temperature, bridge-voltage) or the ready state, if the *STO* is inactivated.

5.6.3.2 Serious Case

In addition to these standard *Safe-States*, there are a couple of *Safe-Error-States*. These require a user initiated reset for recovery. During recovery, there is a power-up test of the internal diagnostic circuit which takes about 100ms. The important causes from a user perspective are:

- If the logic levels of the two channels are not equal during more than $t_{Inconsistent}^{STO}$, the servo drive enters the safe error state *STO-Inconsistent*.
- Internal diagnostic startup test failure: The servo drive enters the safe error state *startup test of the safety circuit failed*.
- Internal periodic pulse test failure: The servo drive enters the safe error state *STO-PulseTestFailure*.
- If the internal diagnostic circuit temperature is out of range, the servo drive enters the safe error state *STO-Temperature-Limit*.

Safety Information	
	A spontaneous defect of two power semiconductors may cause a maximum movement of 120° (electrically).

Voltages outside of the specifications:

- The STO inputs are protected up to voltages of 60V.
- If the 24V Supply voltages exceed ~33V, the servo drive will enter and remain in the safe state. There is both a non-resettable Fuse and a resettable eFuse protecting the drive.
- Under voltage supply below 24V-10% causes the drive to enter the safe state.

5.6.4 Safety Characteristic Data

The following table shows safety specification (in addition to the electrical *STO* specification in chapter 5.2.1).



	Value
Safety level	SIL3 Ple CAT 4
PFH	$1.59 \cdot 10^{-10} \text{ h}^{-1}$
PFD	$2 \cdot 10^{-4}$ (Proof-Test Interval equals Mission Time)
SFF	99.96% for <i>STO</i> (Hardware Fault Tolerances HFT1)
Type	A (according to 61508-2:2010 7.4.4.1.2)
DC	99.42%
MTTF _D	833.3a (For Category 4, the MTTF _D is limited to 2 500 years.)
Mission time TM	20a

5.6.5 Prohibited Use

The *STO* function must not be used in the following cases:

- Cleaning
- Maintenance
- Repair operations
- Long inoperative periods

In such cases, the entire system should be disconnected from the supply by the personnel and secured.

Symbol	Safety Information
 CAUTION	<p>Risk of injury from suspended loads! If the <i>STO</i> function is activated, the amplifier cannot hold the load, the motor no longer supplies torque. Axes with suspended loads must also be safely blocked mechanically (e.g. with the motor holding brake). If engaged during operation, the motor runs down out of control. There is no possibility of braking the axes controlled. If a controlled braking before the use of <i>STO</i> is necessary, the servo drive must be braked and the <i>STO</i> inputs have to be separated from +24 VDC in a time-delayed manner.</p> <p>Keep to the following functional sequence when <i>STO</i> is used:</p> <ol style="list-style-type: none"> 1. Stop the servo drive in a controlled manner (command stop or emergency stop) 2. When speed = 0, disable the servo amplifier (enable = 0V) 3. If there is a suspended load, block the servo drive mechanically 4. Activate <i>STO</i> (STO1-Enable and STO2-Enable = 0V)
 DANGER	<p>The function <i>STO</i> does not provide an electrical separation from the power output. If access to the motor power terminals is necessary, the servo amplifier must be disconnected from mains supply considering the discharging time of the intermediate circuit. There is a danger of electrical shock with personal injury.</p>

5.7 Commutation Frequency Limitation

The European Union issued export restrictions for frequency converters to some countries. Under some conditions, export to these countries is simplified. Triamec servo drives for simplified export contain a limitation of the commutation frequency described in this document. For the correct ordering details refer to chapter 3.1.4.

A product, ordered without high speed capability, contains the frequency limitation feature. This limits the electrical commutation frequency to 600Hz. Moves with speed above this commutation frequency limit will throw the error *Commutation600HzLimit* and the axis stops.

The commutation frequency is related to the mechanical speed by the following equations:

5.7.1 Rotational Motor

The following formula checks if the high speed capability is necessary for a rotational motor.

$$\frac{n \cdot p}{60 \text{ s/min}} = \frac{\text{axis}[\text{ }].\text{signals}.\text{commutation}.\text{velocity}}{2 \cdot \pi} < 600 \text{ Hz}$$

$n[\frac{1}{\text{min}}]$: mechanical speed

p : pole-pairs per turn

5.7.2 Linear Motor

The following formula checks if the high speed capability is necessary for a linear motor.

$$\frac{v}{d_m} = \frac{\text{axis}[\text{ }].\text{signals}.\text{commutation}.\text{velocity}}{2 \cdot \pi} < 600 \text{ Hz}$$

$v[\frac{m}{s}]$: velocity

$d_m[m]$: distance of the magnetic period

5.7.3 DC Motor

No limitation

5.8 Mechanical Specifications



	TSD80/TSD130
Weight	1200g
Dimensions: W x H x D	53 x 230 x 170mm ³

5.9 Ambient and Mounting Conditions

	TSD80/TSD130
Site altitude	up to 1000m above sea level without restriction, higher than 1000m above sea level with reduced power 1% per 100m, max. 2000m above sea level
Mounting Position	Vertical or horizontal, see 6.2
Ambient temperature in operation	According to IEC 60721-3-3 class 3K3 +5°C (41°F) to +40°C (104°F), max. rate of change 20K / hour
Humidity in operation	5 to 85% without condensation
Cooling System	The unit has a fan which is speed controlled. This increases the life time of the fan and reduces acoustic noise. Care should be taken not to block the air inlet on the right side of the unit. The servo drive is equipped with temperature monitoring at various positions inside the drive, which switches the servo drive off in case of over-temperature. The servo drive switches off if the heat sink temperature is above 75°C (167°F).
Enclosure protection	IP 20 (according to IEC 60529 standard), if mating connectors are plugged into X40.1 or X41.1 for unused axes.
Pollution Level	Level 2 as per IEC 60664-1
Type of installation 	Built-in unit, only for installation in a stationary control cabinet with min. degree of protection IP4x. According to EN ISO 13849-2 the control cabinet must have degree of protection IP54 or higher when using the safety function STO (Safe Torque Off).
Vibrations of System	The servo drive is intended for stationary use only and must not be installed in areas where they would be permanently exposed to vibrations. The mechanical conditions must respect the class 3M3 of the IEC 60721-3-2 standard.

6 Mechanical Installation

6.1 Safety Instructions

Symbol	Safety Information
	<ul style="list-style-type: none"> - There is a danger of electrical shock by high EMC level which could result in injury, if the servo amplifier (or the motor) isn't properly EMC-grounded. - During installation work strictly avoid that drill chips, screws or other foreign substances drop into any device. Strictly prevent the devices from moisture. - Protect the servo amplifier from impermissible stresses. In particular, do not let any components become bent or any insulation distances altered during transport and handling. Avoid contact with electronic components and contacts.
	<ul style="list-style-type: none"> - The device heats up during operation and the temperature on the heat sink may reach high temperatures. Please bear this in mind for adjacent components. - Cooling air must be able to flow through the devices without restriction. For installation in control cabinets with convection, always fit an internal air circulation fan. - The servo drive will switch-off itself in case of overheating. Ensure that there is an adequate cooling in the control cabinet.
	<ul style="list-style-type: none"> - Protect the servo amplifier from impermissible stresses. In particular, do not let any components become bent or any insulation distances altered during transport and handling. Avoid contact with electronic components and contacts.

Notice: Do not mount devices, which produce magnetic fields, directly beside the servo drive. Strong magnetic fields could directly affect internal components. Install devices which produce magnetic field with distance to the servo drive and/or shield the magnetic fields.

6.2 Guide to Mechanical Installation

The following notes help to carry out the mechanical installation.

6.2.1 Drawing

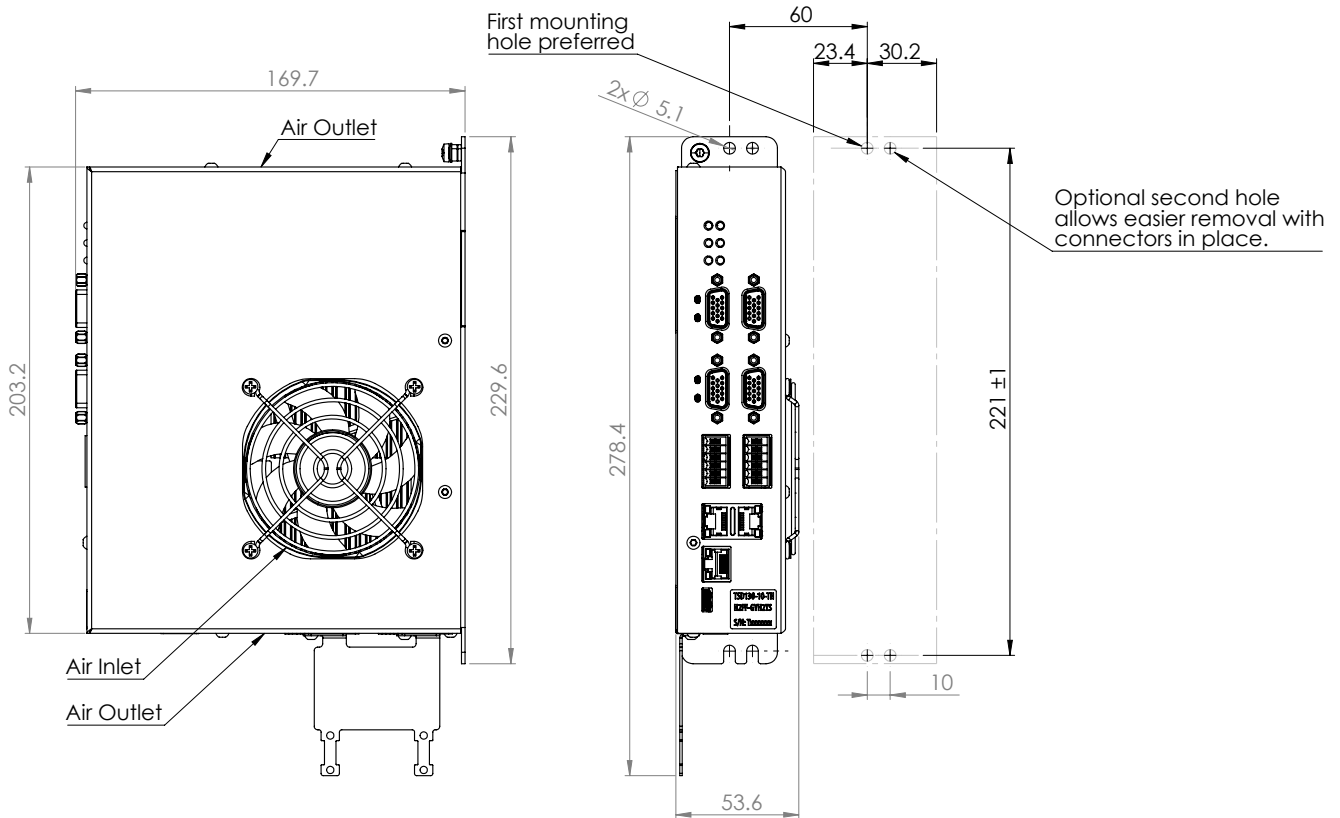

Figure 2: Mechanical Drawing

6.2.2 Site

- The servo drive should be mounted into a lockable control cabinet. Refer to chapter 5.9.
- The site must be free from conductive or corrosive materials.

6.2.3 Cooling

- The servo drives shall be spaced with a gap of 10mm laterally.
- Do not cover air inlets and outlets with cables.
- The servo drive will shut down if the temperature on the PCB, below the power stage, reaches 75°C.

6.2.4 Mounting

- Assemble the servo drives and power supply close together, on the conductive, grounded mounting plate in the cabinet.
- Mount the servo drive preferably in vertical position as depicted in Figure 2 and 3 (horizontal position is allowed too).
- There are four mounting holes for this purpose at the back side of the drive.

	TSD80/TSD130
Gap between drives	10mm
Screws	4 x M4 or M5
Hole Spacing	221 ± 1mm

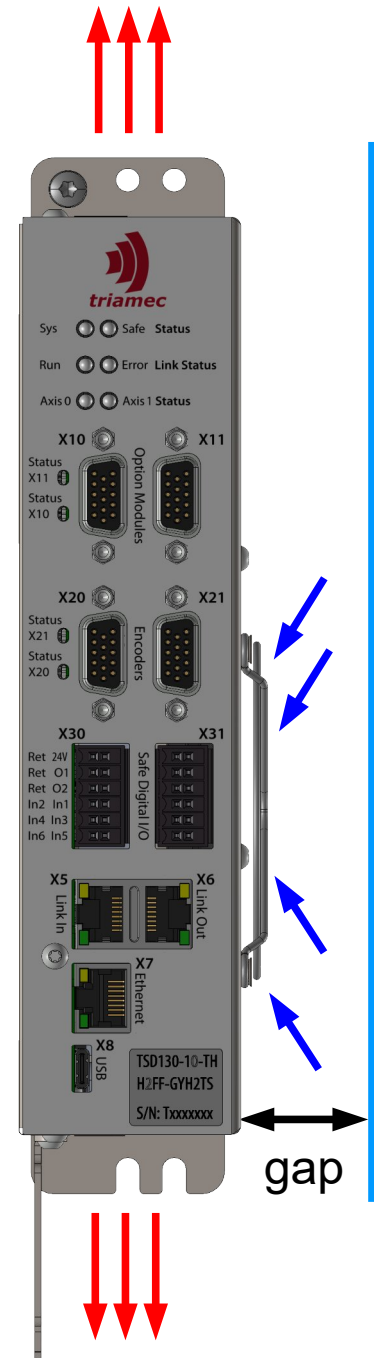







Figure 3: Mounting and cooling

7 Electrical Installation

7.1 Safety Instructions

Symbol	Safety Information
	<p>There is a danger of electrical arcing with serious personal injury. Never connect or disconnect electrical connections while power of any source is on. Isolate the device from the power supply before working on it. Wait at least ten minutes after disconnecting the servo drive from the main supply power before touching potentially live sections of the equipment (e.g. contacts) or undoing any connections.</p> <p>Control and power connections can still be live, even if the motor is not rotating. Capacitors can still have dangerous voltages present up to five minutes after switching off the power supply. Work on the device must only be carried out, after the DC link voltage has dropped below a residual voltage of 40V (to be measured on terminal X1).</p>
	<p>Installation is permitted for properly qualified personnel only. Only professional staff who are qualified in electrical engineering are allowed to install the servo drive. The qualified personnel must know and observe the following standards:</p> <ul style="list-style-type: none"> • IEC 60364 and IEC 60664 • national accident prevention regulations
	<p>During installation work strictly avoid that screws, cable oddments or other foreign substances drop into any device. Strictly prevent the devices from moisture.</p>
	<p>Wrong DC-Bus voltage, unsuitable motor or wrong wiring will damage the amplifier. Check the combination of servo amplifier and motor. Compare the rated voltage and current of the units. Implement the wiring according to the connection diagram in Chapter 7.5. Make sure that the maximum permissible rated voltage at the terminal X1 is not exceeded by more than 5%.</p>
	<p>Risk of electric shock – More than one disconnect switch is required to de-energize the equipment before servicing.</p>

Notice: Compliance with the EMC product standard Commissioning (i.e. starting intended operation) is only permitted when strictly complying with EMC product standard EN 61800-3:2022. The installer/operator of a machine and/or equipment must provide evidence of the compliance with the protection targets stipulated in the EMC-standard.

Notice: Correct wiring is the basis for reliable functioning of the servo system. Route power and control cables separately. We recommend a distance of at least 100mm. This improves the interference immunity.

Notice: Use only shielded motor and signal lines with at least 70% shielding coverage.

Notice: Feedback lines may not be extended, since thereby the shielding would be interrupted and the signal processing could be disturbed.

- Notice:** Always route the motor cable without interruptions and the shortest way out of the control cabinet.
- If possible enter signal lines only from one side into the control cabinet.
 - Lines of the same electric circuit must be twisted.
 - Avoid unnecessary cable lengths and loops.

7.2 Guide to Electrical Installation

The following notes help to carry out the electrical installation. The installation procedure is described as an example. A different procedure may be appropriate or necessary, depending on the application of the equipment.

7.2.1 Connectors and Cables

- Select cables according to the specification of each connector in chapter 7.

7.2.2 Grounding

- For EMC grounding refer to chapter 7.5.1 and 7.12.1.
- Make sure there are two protective earth connections.
- Ground the mounting plate, motor housing and the GND of the control system.

7.2.3 Wiring and Shielding

- Route power leads and control cables separately.
- Connect the protective earth (PE) to the dedicated screws!
- Wire the STO contacts as discussed in chapter 7.7.
- Connect the digital inputs and outputs.
- Connect the auxiliary Supply for the digital outputs.
- Connect the feedback device (encoder) and its shielding.
- Connect the motor cable and its shielding at both ends.
Make sure the length is within the EMC specification in chapter 5.3.
- Connect motor-holding brake if needed and its auxiliary supply, connect shielding at both ends.
- Connect the DC-Bus to the Power supply. Make sure the DC-Bus connection to the power supply is as short as possible.
- Connect the fieldbus (*Tria-Link* or *EtherCAT*).

7.2.4 Final Check

- Final check of the wiring against the wiring diagrams that have been used.

7.3 Overview of Servo Drive Connections

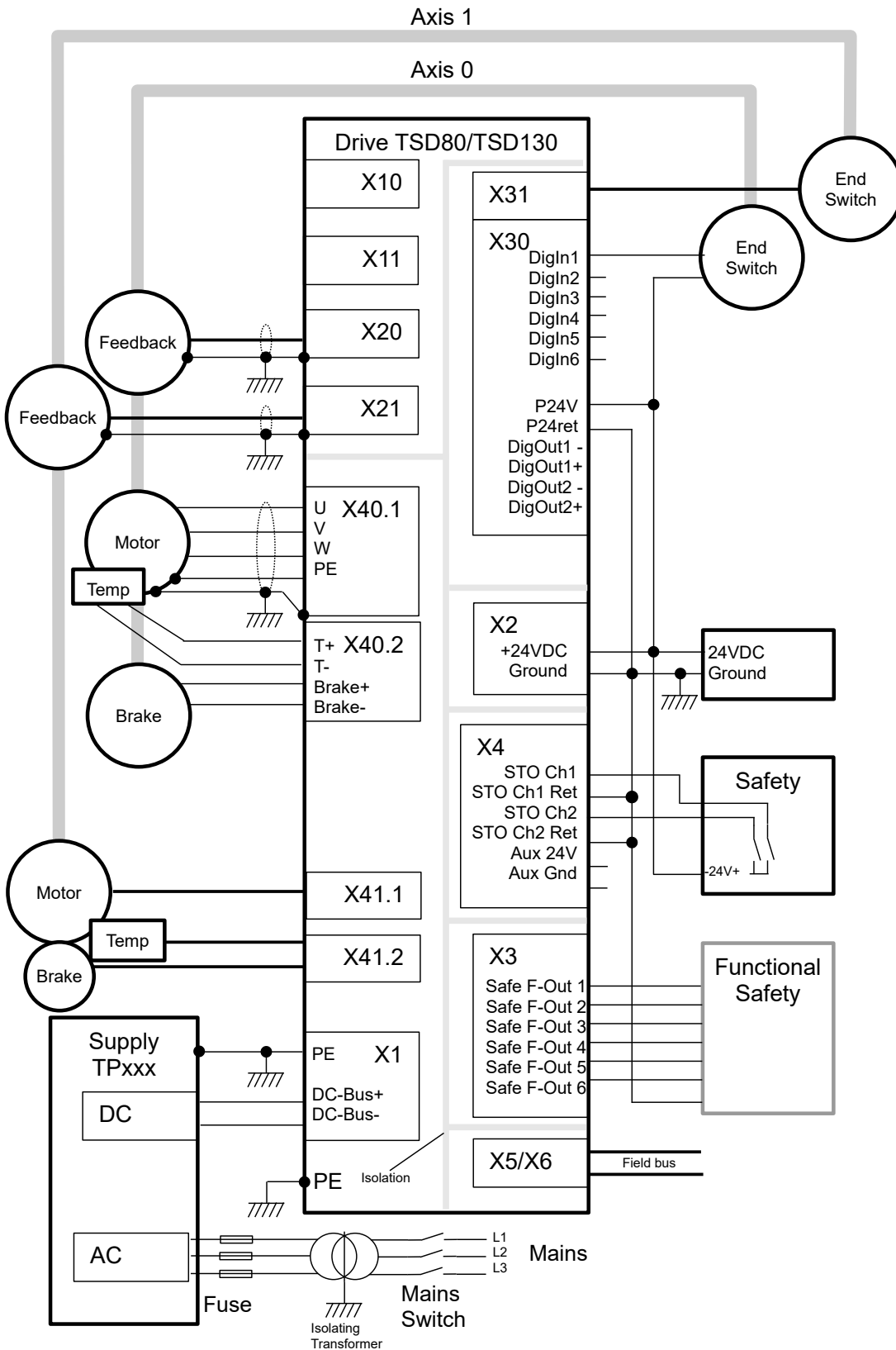

Figure 4: Connection diagram TSD80/TSD130

7.4 Connectors and Terminals

The illustration on the right side shows the servo drive with the corresponding positions of plugs and terminals. All signals of the servo drive are accessible from the front plate. Power connectors, STO, Functional Safety and 24V supply are at the top side of the drive. Motor connectors are located at the bottom of the drive.

The second earth contact PE and the PE wire of connector X1 must both be connected to protective earth with a wire cross-section equivalent to the DC-Bus wires or more.

The table below gives an overview for each connector. The column on the far right contains a reference to a sub chapter or application note with further details.

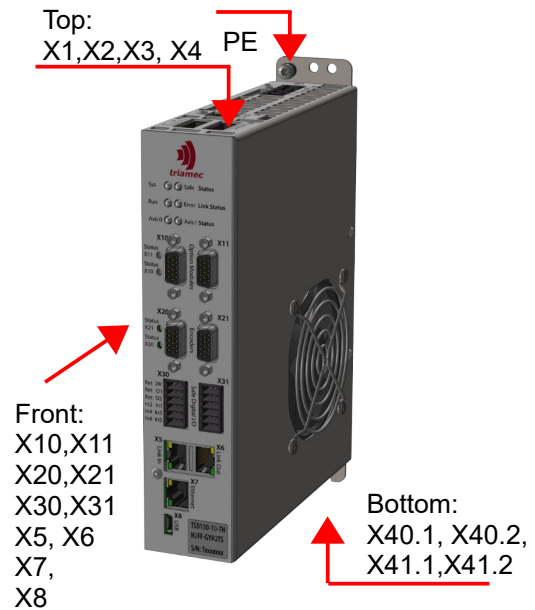

Figure 5: Overview of the connectors

Connector	Direction	Terminals	Mating Connector Type	Details
X1	In	DC-Bus	Weidmüller, BVF 7.62HP/03/180MF2 SN BK BX Order-No.: 1060570000, 3 pins, 7.62mm pitch, <i>From Rev. 5C</i>	7.5.1
X2	In	Logic Supply (24V)	Weidmüller, BLF 5.08HC/02/180 SN BK BX Order-No.: 1013430000, 2 pins, 5.08mm pitch	7.5.2
X3	Out	State Output	Weidmüller, BL 3.50/06/180 SN BK BX Order-No.: 1610180000, 6 pins, 3.5mm pitch	5.6, 7.6
X4	In	Safe Torque Off	Weidmüller, BL 3.50/06/180 SN BK BX Order-No.: 1610180000, 6 pins, 3.5mm pitch	5.6, 7.7
X5/X6	In/Out	<i>Tria-Link</i> or <i>EtherCAT</i>	RJ-45 connector	7.8
X7	In/Out	The Ethernet connector can be connected to a TCP/IP Network. It's possible to monitor and configure the servo drive within Triamec <i>TAM System Explorer</i> .		[7]
X8	In/Out	The USB connector (Type-C) can be connected to a Microsoft® Windows® based notebook/PC. It's possible to monitor and configure the servo drive within Triamec <i>TAM System Explorer</i> .		[3]
X10/X11	In/Out	Option modules	15 pin Sub-D high-density connector (male)	7.9
X20/X21	In	Encoder	15 pin Sub-D high-density connector (male)	7.10
X30/X31	In/Out	Digital I/O	Weidmüller, B2CF 3.50/12/180LH SN BK BX Order no.: 1375750000 (for coding, see option ⁵)	7.11
X40.1/ X41.1	Out	Motor(s)	Weidmüller, BLF 5.08HC/04/180 SN BK BX Order no.: 1013450000 4 pins, 5.08mm pitch	7.12.1
X40.2/ X41.2	In	Motor Temperature Brake	Weidmüller B2CF 3.50/04/180 SN BK BX Order no.: 1277460000 4 pins, 3.5mm pitch	7.12.2

7.5 Electrical Supplies (X1, X2)

The power supply for the servo drive is separated into the supplies for logic and power sections.

Notice: The DC-Bus voltage can be switched on and off independently of the Logic Power. Standard operating procedure, however, is to power the logic before powering DC-Bus.

7.5.1 DC-Bus (X1)

The servo drive must be supplied with a DC voltage source as specified in chapter 5.2.1. Use the DC-bus connector X1 at the top side of the drive. There must be two protective earth connections.

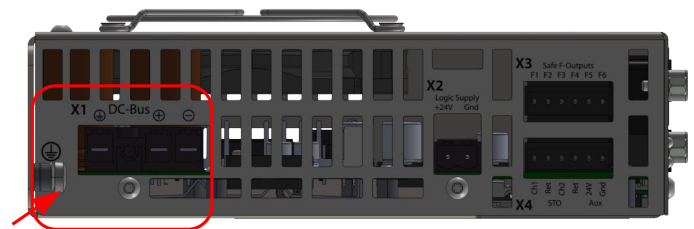
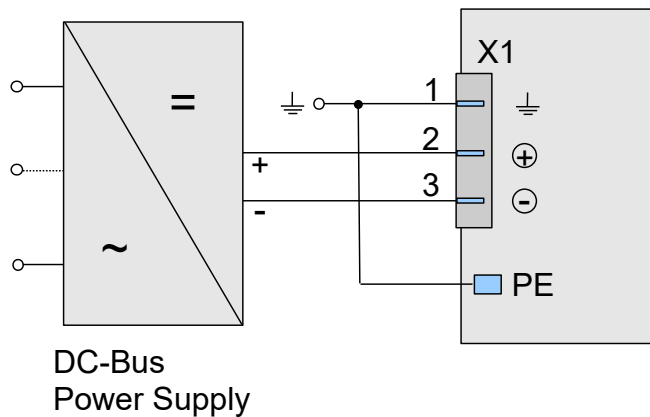

Figure 7: DC-Bus connector (X1)

Figure 6: DC-Bus connection

Pin Layout X1	Pin	Name	Description	Min. Cross Section of Wire	Max. Current
	1	PE	Protective earth	Same or larger than DC-Bus	
	2	+DC-Bus	DC- Bus positive voltage	TSD80-10: 2.5mm ² TSD80-15: 4.0mm ²	20 Arms 30 Arms
	3	-DC-Bus	DC-Bus ground	TSDxxx-10: 2.5mm ² TSD80-15: 4.0mm ²	20 Arms 30 Arms

Information	
	Hot-plugging of the DC-bus link connector is strictly forbidden. The servo drives have large internal capacitors. It is therefore also forbidden to have a simple power-switch or relay in the DC-bus link, because this will also cause large inrush currents. A power-switch or relay in the DC-bus link is allowed only, if it has a soft-start functionality as supplied by the <i>Triamec</i> power supplies <i>TP50</i> , <i>TP80</i> and <i>TP130</i> .
	Please note if not using a <i>Triamec</i> power supply: The servo drives have no built in brake-resistor. When decelerating a mechanical load, currents can get negative, refer to chapter 5.5.

Notice: The Triamec Motion AG power supplies *TP50*, *TPDC50*, *TP80*, *TPDC80* and *TP130*, *TPDC130* complement these servo drives that do not include an integral power supply. Its recommended to use the Triamec power supplies, see also chapter 5.3 on EMC.

Notice: The DC-Bus power supply always must be galvanically isolated from the supply mains to comply with isolation requirements according to EN 61800-5-1.

7.5.1.1 Port Ratings

	Limit TSD80-06	Limit TSD80-10	Limit TSD80-15	Limit TSD130-10
maximum nominal input voltage	80V	80V	80V	130V
maximum nominal input current RMS	12A	20A	30A	20A
maximum nominal output voltage	Input	Input	Input	Input
maximum nominal output current	Input	Input	Input	Input
number of phases	1	1	1	1
protective class	I	I	I	I
DVC classification	B	B	B	C
electrical overvoltage category	II	II	II	II
Rated conditional short-circuit current on input power ports	(overcurrent protection implemented by supplying device)			
Available output short-circuit current	Input	Input	Input	Input
Protective device characteristics	(overcurrent protection implemented by supplying device)			

7.5.2 24V Logic Supply (X2)

The servo drive requires a 24V DC supply for its internal logic and for the supply of the connected encoders. The Logic Supply connector X2 is found at the top side of the drive.

The servo drive internal supplies are galvanically isolated from the 24V DC logic supply input, especially the encoder supply and the motor temperature input. The STO supply used to bypass STO is not galvanically isolated from this input.

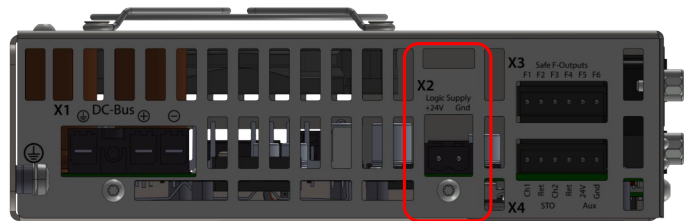



Figure 8: 24V Logic supply connector (X2)

Pin Layout X2	Pin	Name	Description
	1	+24VDC	Supply logic positive voltage
	2	Ground	Supply ground

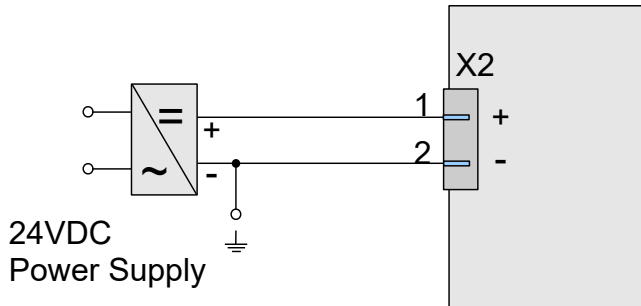



Figure 9: 24VDC logic power supply connection

Information	
 CAUTION	As per EN 61800-5-1, the used power supply must have a safe and reliable galvanic isolation towards the mains network.

Notice: It's recommended, to connect the 0VDC (-) to earth potential near the power supply. This ensures that the low voltage side complies with PELV.

7.5.2.1 Port Ratings

	Limit
maximum nominal input voltage	24V ±10%
maximum nominal input current RMS	1.7A
maximum nominal output voltage	Input
maximum nominal output current	Input
number of phases	1
protective class	I
DVC classification	A (Not for use in wet locations)
electrical overvoltage category	I
Rated conditional short-circuit current on input power ports	50A@63V
Available output short-circuit current	Input
Protective device characteristics	Internal fused: eFuse 2.14A ±6% and 4A fast acting UL rated Fuse

7.6 Safe Function Outputs (X3)

The Safe Function Output connector X3 is found at the top side of the drive. The cable must be shorter than 20m. Use shielded cables if longer than 0.5m.

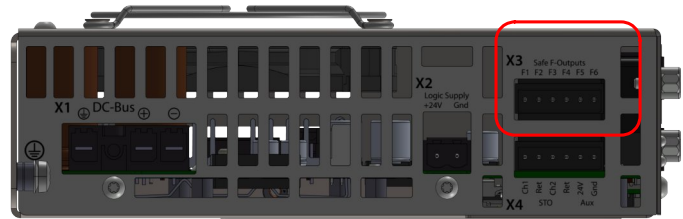



Figure 10: Safe Function Outputs connector (X3)

Pin Layout X3	Pin	Name	Description
	1	Safe F-Output F1	Safe Function Output F1
	2	Safe F-Output F2	Safe Function Output F2
	3	Safe F-Output F3	Safe Function Output F3
	4	Safe F-Output F4	Safe Function Output F4
	5	Safe F-Output F5	Safe Function Output F5
	6	Safe F-Output F6	Safe Function Output F6

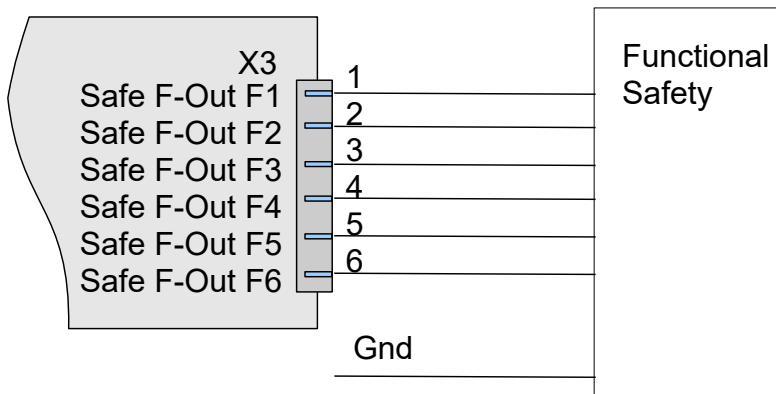

Figure 11: Wiring of the State Outputs

Internal 100nF capacitor. Use minimal load for testpulses (about 5kOhm to Aux Gnd or X2 Gnd)

7.6.1.1 Port Ratings

	Limit
maximum nominal input voltage	Output
maximum nominal input current RMS	Output
maximum nominal output voltage	24V
maximum nominal output current	50mA
number of phases	n/a
protective class	I
DVC classification	A (Not for use in wet locations)
electrical overvoltage category	I
Rated conditional short-circuit current on input power ports	n/a
Available output short-circuit current	Current typically limited to 110mA
Protective device characteristics	n/a

7.7 Safe Torque Off STO (X4)

The STO connector X4 is found at the top side of the drive. The cable must be shorter than 20m. Use shielded cables if longer than 0.5m.

STO inputs according to IEC 61131-2 Type 1.

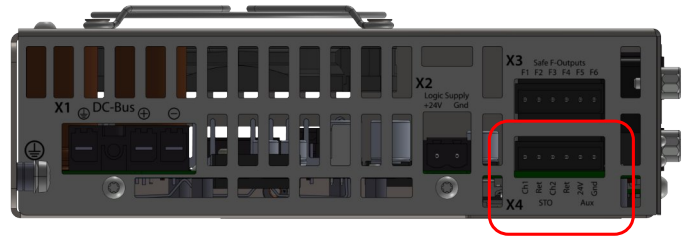

Figure 12: STO connector (X4)

Pin Layout X4	Pin	Name	Description
	1	STO Input Ch1	STO channel 1 input
	2	STO Return Ch1	STO channel 1 GND ⁶
	3	STO Input Ch2	STO channel 2 input
	4	STO Return Ch2	STO channel 2 GND ⁶
	5	Aux 24 V	24V for STO, if STO is not used (connect to Pin 1 and 3 of X4)
	6	Aux Gnd	Ground for STO, if STO is not used (connect to Pin 2 and 4 of X4)

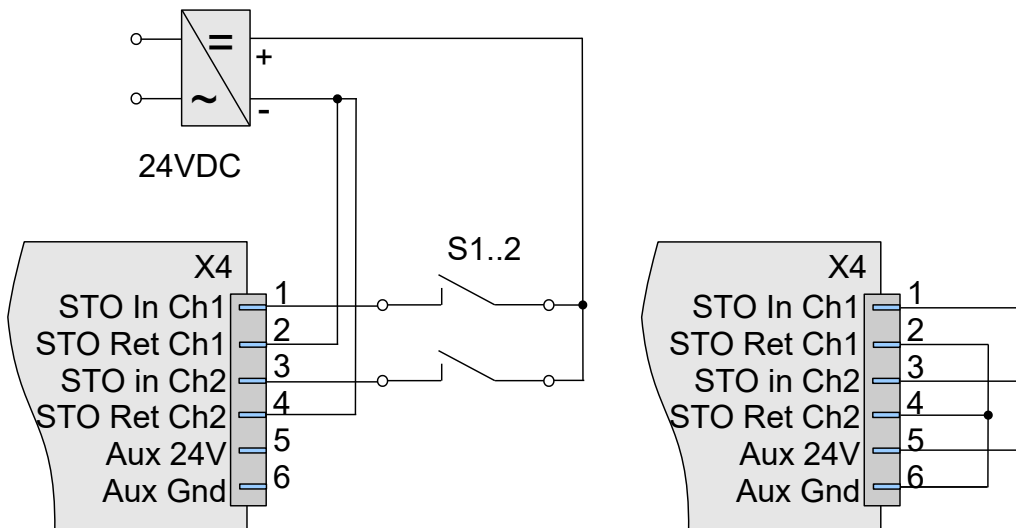

Figure 13: Wiring of the STO used (left) and not used (right)

⁶ Pin 2 and 4 are internally not connected

7.7.1.1 Port Ratings

	Pins	Limit
maximum nominal input voltage	STO	24V
maximum nominal input current RMS	STO	2.25mA
maximum nominal output voltage	AUX	24V
maximum nominal output current	AUX	50mA
number of phases		n/a
protective class		I
DVC classification		A (Not for use in wet locations)
electrical overvoltage category		I
Rated conditional short-circuit current on input power ports		n/a
Available output short-circuit current	AUX	Current typically limited to 110mA
Protective device characteristics	STO	Galvanically insulated, no protection required
	AUX	Current typically limited to 110mA

7.8 Fieldbus Connection (X5, X6)

The servo drive communicates with the host (and other devices) using one of two Ethernet based fieldbuses.

Consult [9] for more information on field bus connection.

7.8.1 Tria-Link

This is a flexible bus developed by Triamec. The servo drive must be connected with the other Triamec devices and the *Tria-Link* Master (e.g. Triamec PCI Adapter card) forming a **ring topology**. Both jacks (X5, X6) are equivalent, they can be used in any order and are completely interchangeable.

Each *Tria-Link* RJ-45 connector has two LEDs:

- The green LED (Link LED) is normally blinking. This indicates that the *Tria-Link* is connected to the next device. If one of the green LEDs is not blinking, it indicates an open link to the next device. Check device 24V and the cable/Ethernet connector in this case.
- The yellow LED (Lock LED) indicates a successful time synchronization of all devices in the *Tria-Link*, and thus that the link is ready. If the yellow LED is not illuminated at least ~5sec after servo drive start up, the *Tria-Link* is either:
 - ♦ open, i.e. the ring is not closed or an Ethernet connector is not engaged
 - ♦ one or more devices are not powered
 - ♦ a device has a hardware fault.

7.8.2 EtherCAT

This is a fieldbus disclosed in the IEC standard IEC61158 with real-time capability. It was originally developed by Beckhoff Automation and is now managed by the *EtherCAT* Technology Group (ETG).

The servo drive must be connected to the *EtherCAT* PCI-Adapter card and the other Triamec devices in a **chain topology** starting with the Adapter card. The jacks (X5(Line In), X6(Line Out)) are not equivalent, the control flow has to be regarded.

- In contrast to the *Tria-Link*, the cyclic data is defined at boot time and cannot be changed later. This makes debugging through the fieldbus less flexible than with the *Tria-Link*. However, customers may still use the USB or Ethernet interface for debugging within Triamec *TAM System Explorer*.
- Exchange of cyclic data between slaves is less flexible than with *Tria-Link* and is not supported.

Each *EtherCAT* RJ-45 connector has two LEDs:

- The green LED (Line In) is on, to indicate that the servo drive is connected to the Controller. If the green LED is Off, it indicates an open connection. Check device 24V and the cable/Ethernet connector in this case.
- The yellow LED (Line Out) is normally Off, except the LED of the last Device in the chain is flashing.

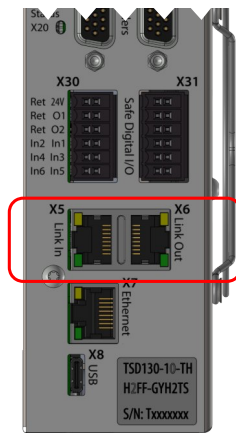

Figure 14: Link jacks (X5, X6)

7.8.2.1 Port Ratings

	Limit
maximum nominal input voltage	3.3V
maximum nominal input current RMS	10uA
maximum nominal output voltage	2.5V
maximum nominal output current	25mA
number of phases	n/a
protective class	I
DVC classification	A (Not for use in wet locations)
electrical overvoltage category	I
Rated conditional short-circuit current on input power ports	n/a
Available output short-circuit current	n/a
Protective device characteristics	n/a

7.9 Option Modules (X10, X11)

Two option module connectors provide access to extended functions. *Option Module* orders are defined with the drive order key and are installed during production. Post-production installations are possible by sending the drive back to *Triamec*.

Chapter 3.1.5 describes the different available options. Refer to [6] for further informations about functionality and software access.

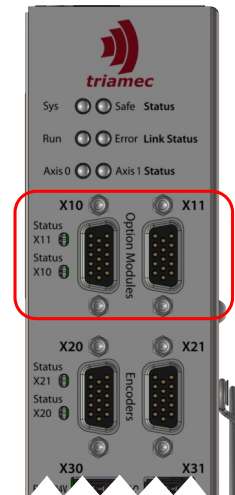

Figure 15: Option module jacks (X10,X11)

7.9.1.1 Port Ratings

	Pin	Limit
maximum nominal input voltage	EnIn0x	5V
maximum nominal input current RMS	EnIn0x	<3mA
maximum nominal output voltage	+5VDC	5.2V
maximum nominal output current		Depending on Module see [6]
number of phases		n/a
protective class		I
DVC classification		A (Not for use in wet locations)
electrical overvoltage category		I
Rated conditional short-circuit current on input power ports		n/a
Available output short-circuit current		Depending on Module see [6]
Protective device characteristics		n/a

7.10 Encoder (X20, X21)

Two encoder connectors are available by default (two more are available with option modules). They are located at the front side of the drive. X20 feeds axis 0. X21 feeds axis 1.

Each connector supports various encoder types/protocols and up to four high speed TTL inputs (200ns).



Figure 16: Encoder jack (X20,X21)

Type	Description
Analog sin/cos Encoder with Index	High resolution analog sin/cos encoder with index channel.
Digital Encoder with sin/cos Signals	High resolution analog encoder combined with absolute encoder position, which is transmitted digitally.
Digital Encoder without sin/cos Signals	Digital encoder without analog sin/cos signals. Encoder specifications limit the maximum possible update rate of the position controller.
Incremental RS422 Encoder with Index	RS422 incremental encoder.
Incremental RS422 Fast Encoder	RS422 encoder input for frequencies up to 10MHz.
Incremental TTL Encoder with Index	TTL incremental encoder.

	Information
	<ul style="list-style-type: none"> - Make sure the encoder plug is well connected by means of the D-Sub plug screws. - Do not split encoder cables, for example to route the signals via terminals into the control cabinet. - Connect the case with the shielding of the encoder cable and make sure, that the screen is connected with low impedance (i.e. thick wire, large connection area, 360 degree around the cable) at the servo drive side.

7.10.1 Analog sin/cos Encoder with Index

Analog sin/cos Encoder with index channel.

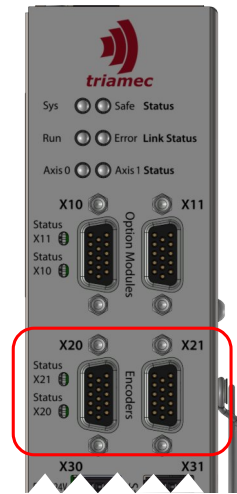
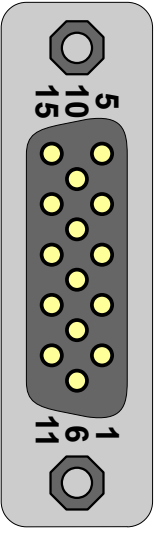

Figure 17: Encoder jack (X20,X21)

Pin Layout X20/X21	Pin	Name	Encoder	
15-pin female D-Sub socket 	1	+5VDC	Encoder Supply	
	2	ChA+	Channel A positive, Cosine 1Vpp	
	3	ChB+	Channel B positive, Sine 1Vpp	
	4	ChZ+	Index channel positive, RS-422 input	
	5	n.c.	do not connect	
	6	Gnd	Supply Ground	
	7	ChA-	Channel A negative, Cosine 1Vpp	
	8	ChB-	Channel B negative, Sine 1Vpp	
	9	ChZ-	Index channel negative, RS-422 input	
	10	n.c.	do not connect	
	11	EnIn0	TTL Level Input No. 0 (max 5VDC Input)	see 7.10.7 for connection
	12	EnIn1	TTL Level Input No. 1 (max 5VDC Input)	see 7.10.7 for connection
	13	EnIn2	TTL Level Input No. 2 (max 5VDC Input)	see 7.10.7 for connection
	14	EnIn3	TTL Level Input No. 3 (max 5VDC Input)	see 7.10.7 for connection
	15	Gnd	Signal Ground	

7.10.2 Digital Encoder with sin/cos Signals

Single-turn or Multi-turn Digital Encoder (EnDat 2.1/2.2, BiSS B, BiSS C, SSI) with analog sin/cos signals. This encoder type is operated as analog sin/cos Encoder. The Absolute position (and some additional information) is read during initialization using the digital serial interface.

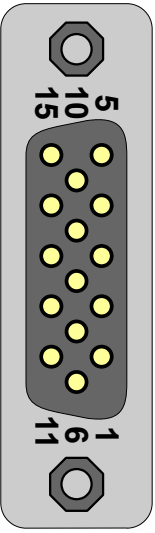

Figure 18: Encoder jack (X20,X21)

Pin Layout X20/X21	Pin	Name	Encoder	
15-pin female D-Sub socket 	1	+5VDC	Encoder Supply	
	2	ChA+	Channel A positive, Cosine 1Vpp	
	3	ChB+	Channel B positive, Sine 1Vpp	
	4	DATA+	Data channel positive, RS-422	
	5	CLOCK+	Clock channel positive, RS-422	
	6	Gnd	Supply Ground	
	7	ChA-	Channel A negative, Cosine 1Vpp	
	8	ChB-	Channel B negative, Sine 1Vpp	
	9	DATA-	Data channel negative, RS-422	
	10	CLOCK-	Clock channel negative, RS-422	
	11	EnIn0	TTL Level Input No. 0 (max 5VDC Input)	see 7.10.7 for connection
	12	EnIn1	TTL Level Input No. 1 (max 5VDC Input)	see 7.10.7 for connection
	13	EnIn2	TTL Level Input No. 2 (max 5VDC Input)	see 7.10.7 for connection
	14	EnIn3	TTL Level Input No. 3 (max 5VDC Input)	see 7.10.7 for connection
	15	Gnd	Signal Ground	

Notice: RS422 index channel is not available in this configuration. TTL index is available through an EnInX.

7.10.3 Digital Encoder without sin/cos Signals

Single-turn or Multi-turn Digital Encoder (Endat 2.2, BiSS B, BiSS C, SSI, Tamagawa, Nikon) without analog sin/cos signals. Digital absolute position information is transmitted at every position controller cycle digitally coded to the position controller.

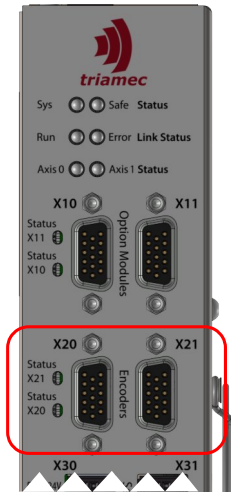
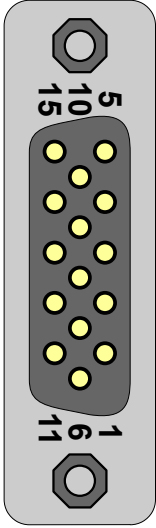

Figure 19: Encoder jack (X20,X21)

Pin Layout X20/X21	Pin	Name	Encoder	
15-pin female D-Sub socket 	1	+5VDC	Encoder Supply	
	2	n.c.	do not connect	
	3	n.c.	do not connect	
	4	DATA+	Data channel positive, RS-422	
	5	CLOCK+	Clock channel positive, RS-422 (not used for Nikon and Tamagawa)	
	6	Gnd	Supply Ground	
	7	n.c.	do not connect	
	8	n.c.	do not connect	
	9	DATA-	Data channel negative, RS-422	
	10	CLOCK-	Clock channel negative, RS-422 (not used for Nikon and Tamagawa)	
	11	EnIn0	TTL Level Input No. 0 (max 5VDC Input)	see 7.10.7 for connection
	12	EnIn1	TTL Level Input No. 1 (max 5VDC Input)	see 7.10.7 for connection
	13	EnIn2	TTL Level Input No. 2 (max 5VDC Input)	see 7.10.7 for connection
	14	EnIn3	TTL Level Input No. 3 (max 5VDC Input)	see 7.10.7 for connection
	15	Gnd	Signal Ground	

Notice: RS422 index channel is not available in this configuration. TTL index is available through an EnInX.

7.10.4 Incremental RS422 Encoder with Index

Connecting an incremental encoder with index channel.

This mode has a 500kHz limit and is provided for backwards compatibility. For new machines we recommend the 10MHz pinout as per 7.10.5 Incremental RS422 Fast Encoder with Index.

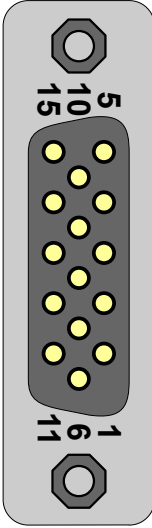

Figure 20: Encoder jack (X20,X21)

Pin Layout X20/X21	Pin	Name	Encoder	
15-pin female D-Sub socket 	1	+5VDC	Encoder Supply	
	2	ChA+	Channel A positive, RS-422 input	
	3	ChB+	Channel B positive, RS-422 input	
	4	ChZ+	Index channel positive, RS-422 input	
	5	n.c.	do not connect	
	6	Gnd	Encoder Ground	
	7	ChA-	Channel A negative, RS-422 input	
	8	ChB-	Channel B negative, RS-422 input	
	9	ChZ-	Index channel negative, RS-422 input	
	10	n.c.	do not connect	
	11	Encln0	TTL Level Input No. 0 (max 5VDC Input)	see 7.10.7 for connection
	12	Encln1	TTL Level Input No. 1 (max 5VDC Input)	see 7.10.7 for connection
	13	Encln2	TTL Level Input No. 2 (max 5VDC Input)	see 7.10.7 for connection
	14	Encln3	TTL Level Input No. 3 (max 5VDC Input)	see 7.10.7 for connection
	15	Gnd	Signal Ground	

7.10.5 Incremental RS422 Fast Encoder with Index

Connecting an incremental RS422 encoder with index for pulse frequencies up to 10MHz.

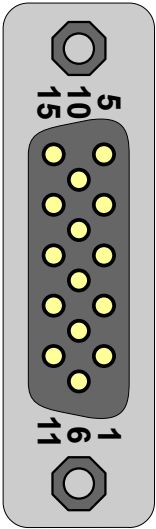

Figure 21: Encoder jack (X20,X21)

Pin Layout X20/X21	Pin	Name	Encoder	
15-pin female D-Sub socket  female D-Sub socket	1	+5VDC	Encoder Supply	
	2	ChZ+	Index channel positive, RS-422 input	
	3	n.c.	(do not connect)	
	4	ChA+	Channel A positive, RS-422 input	
	5	ChB+	Channel B positive, RS-422 input	
	6	Gnd	Encoder Ground	
	7	ChZ-	Index channel negative, RS-422 input	
	8	n.c.	(do not connect)	
	9	ChA-	Channel A negative, RS-422 input	
	10	ChB-	Channel B negative, RS-422 input	
	11	Encln0	TTL Level Input No. 0 (max 5VDC Input)	see 7.10.7 for connection
	12	Encln1	TTL Level Input No. 1 (max 5VDC Input)	see 7.10.7 for connection
	13	Encln2	TTL Level Input No. 2 (max 5VDC Input)	see 7.10.7 for connection
	14	Encln3	TTL Level Input No. 3 (max 5VDC Input)	see 7.10.7 for connection
	15	Gnd	Signal Ground	

7.10.6 Incremental TTL Encoder with Index

Connecting an incremental TTL encoder with index channel via Encln0 and Encln1.

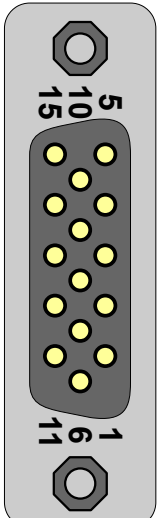

Figure 22: Encoder jack (X20,X21)

Pin Layout X20/X21	Pin	Name	Encoder	
15-pin female D-Sub socket  female D-Sub socket	1	+5VDC	Encoder Supply	
	2	n.c.	do not connect	
	3	n.c.	do not connect	
	4	ChZ+	Index channel positive, RS-422 input	
	5	n.c.	do not connect	
	6	Gnd	Encoder Ground	
	7	n.c.	do not connect	
	8	n.c.	do not connect	
	9	ChZ-	Index channel negative, RS-422 input	
	10	n.c.	do not connect	
	11	Encln0	Channel A	
	12	Encln1	Channel B	
	13	Encln2	TTL Level Input No. 2 (max 5VDC Input)	see 7.10.7 for connection
	14	Encln3	TTL Level Input No. 3 (max 5VDC Input)	see 7.10.7 for connection
	15	Gnd	Signal Ground	

Notice: The source of position latch during homing can be chosen between ChZ (RS-422), Encln2 or Encln3.

7.10.7 TTL Inputs Connection

If digital TTL inputs Encln0 ... Encln3 are used, they must be wired as follows.

There are internal 1.5kOhm pull-down resistors. Shielding is mandatory for better EMC immunity. The shield has to be connected to the D-Sub housing (earth).

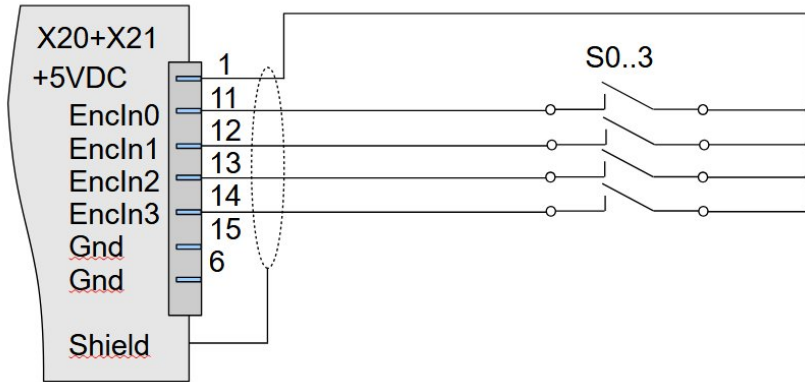

Figure 23: TTL input connection

7.10.7.1 Port Ratings

	Limit
maximum nominal input voltage	5V
maximum nominal input current RMS	3.4mA
maximum nominal output voltage	3.3V
maximum nominal output current	8mA
number of phases	n/a
protective class	I
DVC classification	A (Not for use in wet locations)
electrical overvoltage category	I
Rated conditional short-circuit current on input power ports	n/a
Available output short-circuit current	20mA
Protective device characteristics	n/a

7.11 Digital Inputs and Outputs (X30, X31)

The digital inputs and outputs are available at the front side of the drive. All inputs and outputs are not galvanic isolated from the logic supply. The connectors X30 and X31 are not galvanically isolated to each other. X30 is assigned to axis 0, X31 is assigned to axis 1. Pins 1 & 2 of X30 are connected internally to pin 1 & 2 of X31.

Notice: The outputs require an additional 24VDC power supply. If only the inputs are used, this is not necessary.

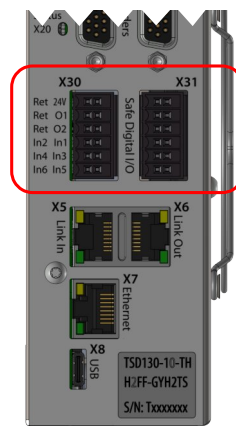

Figure 24: Digital I/O connector (X30+X31)

7.11.1 Digital Inputs

The pin numbering of the connector is shown in the figure below, see chapter 5.2.1 for detailed specifications of the input channels.

Pin Layout X30/X31	Pin	Name	Description	
	2	P24Vret	0V, ground for digital inputs and outputs.	
	7	DigIn1	Digital input 1	Logic low < 5V Logic high > 15V, max 29V
	8	DigIn2	Digital input 2	
	9	DigIn3	Digital input 3	
	10	DigIn4	Digital input 4	
	11	DigIn5	Digital input 5	
12	DigIn6	Digital input 6		

The digital inputs can be connected as depicted in the illustrations below.

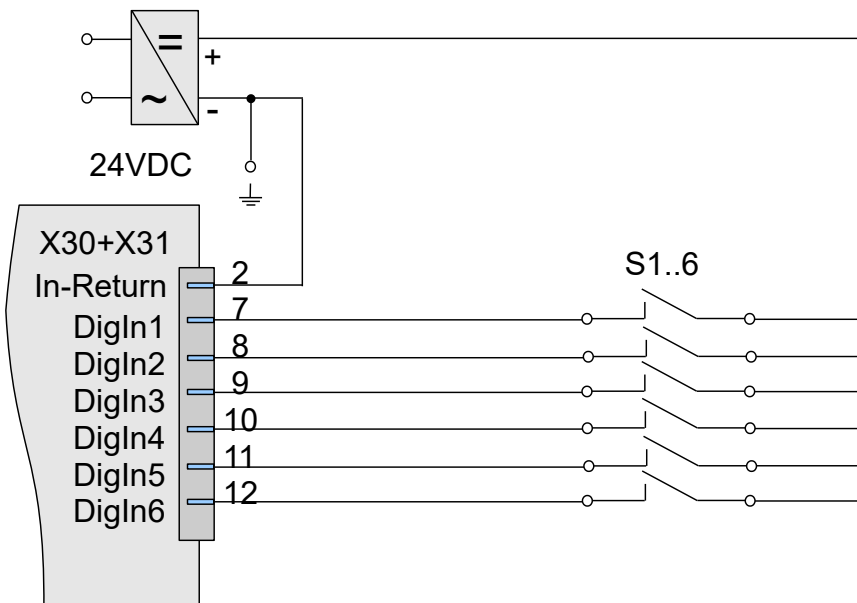

Figure 25: Digital input connection

7.11.2 Digital Outputs

The table below describes the pinout of the output pins, see 5.2.1 for detailed specification of the output channels. The digital outputs are equipped with one high-side and one low-side switch each and require an external 24V_{DC} supply between pin 1 and pin 2 for operation.

Pin Layout X30/X31	Pin	Name	Description
	1	P24V	20...28VDC supply input for digital outputs 1 and 2. Current max. 2.9A continuous.
	2	P24Vret	0V, ground for digital outputs and inputs.
	3	DO1	Digital Output 1 High Side Switch. Connect your load between this pin and pin 4, internally connected with X40.2/X41.2 pin 1 30VDC max, 1A continuous ⁷ , 1.4A peak (1s)
	4	DO1ret	Digital Output 1 return, internally connected with X40.2/X41.2 pin 2
	5	DO2	Digital Output 2 High Side Switch. Connect your load between this pin and pin 6 30VDC max, 1A continuous ⁷ , 1.4A peak (1s)
	6	DO2ret	Digital Output 2 return.

As an example, the following figure shows the connection of a typical motor-brake at output DO1. Brake can also be connected on X40.2/X41.2 see 7.12.2.

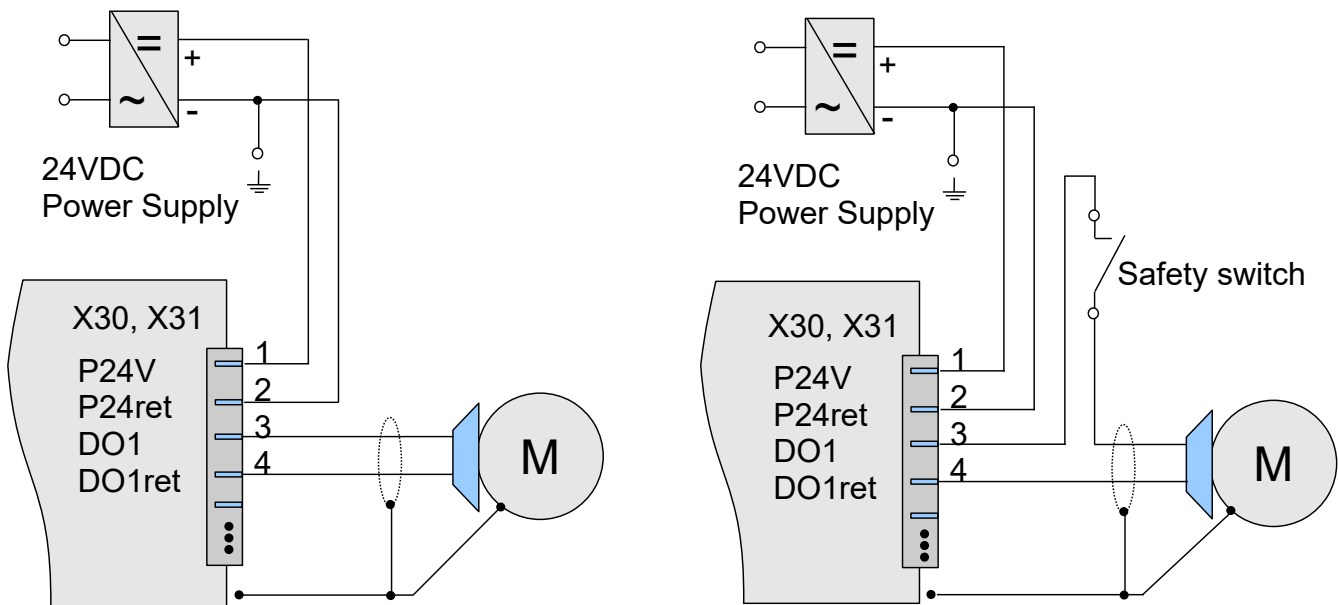

Figure 26: Typical motor brake connection without external safety switch (left), with external safety switch (right)

7 Max. 3.7A continuous for all 4 outputs together

7.11.2.1 Port Ratings

	Limit
maximum nominal input voltage	24V
maximum nominal input current RMS	2.9A on Pin P24V
maximum nominal output voltage	24V
maximum nominal output current	1A
number of phases	n/a
protective class	I
DVC classification	A (Not for use in wet locations)
electrical overvoltage category	I
Rated conditional short-circuit current on input power ports	50A@63V
Available output short-circuit current	1..1.5A per output, 2.9A for all 4 outputs together
Protective device characteristics	Internal fused: eFuse 3.21A \pm 7% and 4A fast acting UL rated Fuse

7.12 Motor Connection (X40, X41)

This connector feeds the motor and the motor temperature sensor.

7.12.1 Motor Power Connection

The servo drive supports different motor configurations. All motor configurations use connectors at the bottom side of the drive. X40.x is for axis 0 and X41.x is for axis 1. The motor cable must be shielded. The illustrations below show all possible motor configurations for each axis.

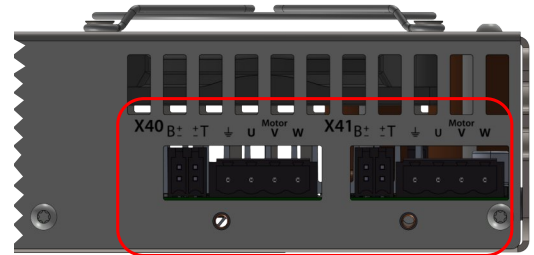

Figure 27: Motor connectors

- Notice:** Make sure protective earth on connector and functional earth on shield are connected properly.
- Notice:** It is recommended to attach the motor shield directly to the electrical earth of the cabinet.
- Notice:** For more information regarding recommended grounding and shielding instructions, refer to Triamec Motion AG Application Note "Grounding Instructions" [8].

7.12.1.1 3-Phase AC Motor Connection

Pin Layout X40.1/ X41.1	Pin	Name	Description	Min. Cross Section of Wire	Max. Current
	1	PE	Protective earth	Same or larger than UVW	
	2	U	Motor phase U voltage	TSDxxx-10: 1.0mm ² TSD80-15: 1.5mm ²	10 Arms 15 Arms
	3	V	Motor phase V voltage	TSDxxx-10: 1.0mm ² TSD80-15: 1.5mm ²	10 Arms 15 Arms
	4	W	Motor phase W voltage	TSDxxx-10: 1.0mm ² TSD80-15: 1.5mm ²	10 Arms 15 Arms

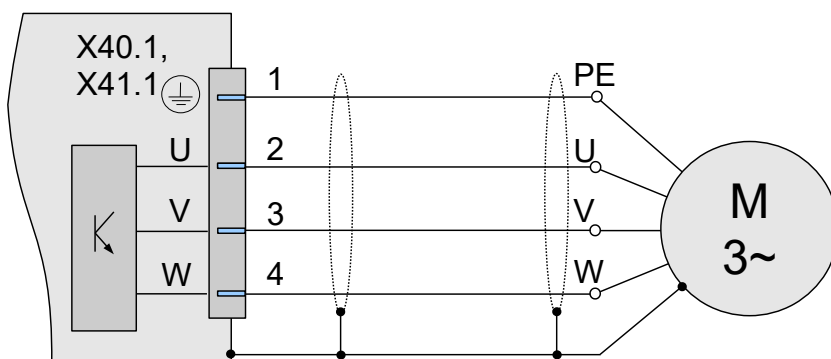



Figure 28: 3-phase motor connection

7.12.1.2 2-Phase AC Motor Connection

Pin Layout X40.1/ X41.1	Pin	Name	Description	Min. Cross Section of Wire	Max. Current
	1	PE	Protective earth	Same or larger than UVW	
	2	U	Motor phase P1 voltage	TSDxxx-10: 1.0mm ² TSD80-15: 1.5mm ²	10 Arms 15 Arms
	3	V	Motor phase P voltage	TSDxxx-10: 1.0mm ² TSD80-15: 1.5mm ²	10 Arms 15 Arms
	4	W	Motor phase P2 voltage	TSDxxx-10: 1.0mm ² TSD80-15: 1.5mm ²	10 Arms 15 Arms

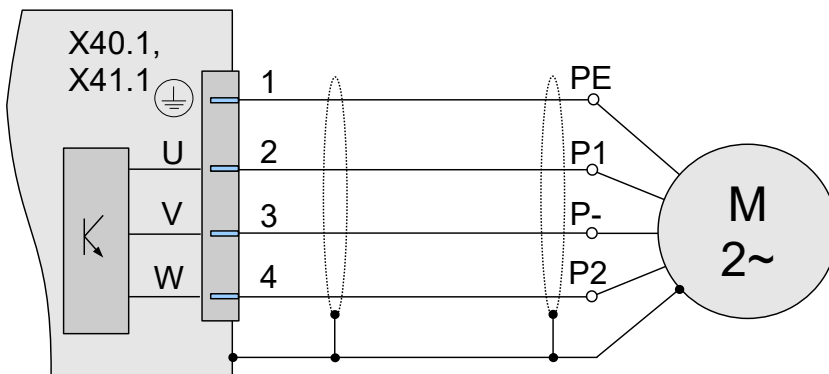



Figure 29: 2-phase motor connection

Notice: In case of a four wire motor, connect both return lines to phase V (Pin 5).

7.12.1.3 DC Motor Connection

Pin Layout X40.1/ X41.1	Pin	Name	Description	Min. Cross Section of Wire	Max. Current
	1	PE	Protective earth	Same or larger than UVW	
	2	U	Motor phase DC+ voltage	TSDxxx-10: 1.0mm ² TSD80-15: 1.5mm ²	10 Arms 15 Arms
	3	V	Motor phase DC- voltage	TSDxxx-10: 1.0mm ² TSD80-15: 1.5mm ²	10 Arms 15 Arms
	4	W	nc	-	-

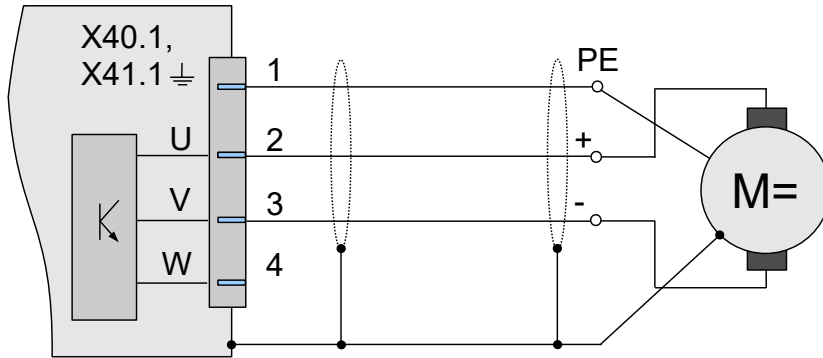

Figure 30: DC-motor connection

7.12.1.4 Port Ratings

	Limit TSD80-06	Limit TSD80-10	Limit TSD80-15	Limit TSD130-10
maximum nominal input voltage	Output	Output	Output	Output
maximum nominal input current RMS	Output	Output	Output	Output
maximum nominal output voltage	100V	100V	100V	150V
maximum nominal output current	6ADC(4.2A rms)	10A	15A	10A
number of phases	3	3	3	3
protective class	I	I	I	I
DVC classification	B	B	B	C
electrical overvoltage category	II	II	II	II
Rated conditional short-circuit current on input power ports	n/a	n/a	n/a	n/a
Available output short-circuit current	6A	20A	30A	20A
Protective device characteristics	n/a	n/a	n/a	n/a

7.12.2 Motor Temperature and Brake Output (X40.2, X41.2)

A resistive motor temperature sensor which measures the temperature of the motor windings may be connected to X40.2 and X41.2, see chapter 5.2.1 for supported types and ranges. Use X40.2 for axis 0 and X41.2 for axis 1.

The connected motor brake is controlled via digital output DO1 of the axis. See chapter 7.11.2 for additional information. 24V supply on X30/X31 pin 1 and 2 is necessary.

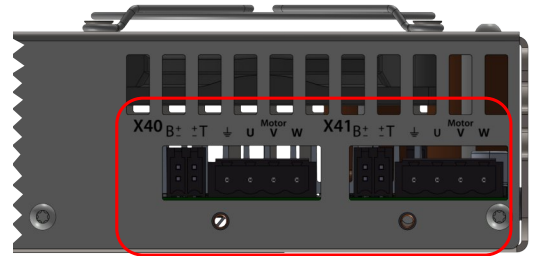

Figure 31: Motor temperature and Brake connector

Pin Layout X40.2/ X41.2	Pin	Name	Description
	1	Brake+	Brake Output +, internally connected with X30/X31 pin 3
	2	Brake-	Brake Output -, internally connected with X30/X31 pin 4
	3	T+	Positive motor temperature input
	4	T-	Negative motor temperature input

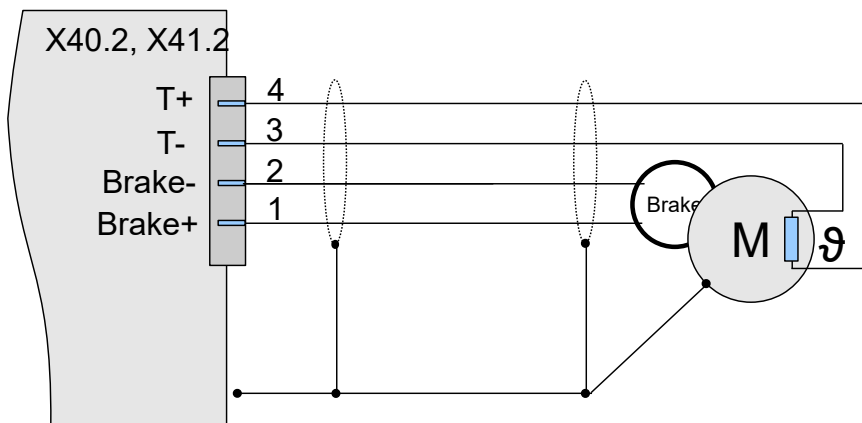

Figure 32: Motor temperature and brake connection

Notice: The temperature measurement input is at the same ground as the DC-Bus negative voltage and is galvanically isolated from the internal logic of the drive.

7.12.2.1 Port Ratings

	Limit T Pins	Limit Brake Pins
maximum nominal input voltage	Sensor interface, $\pm 12V$ protected	output
maximum nominal input current RMS	1mA	output
maximum nominal output voltage	3.3V	24V
maximum nominal output current	1mA	1A
number of phases	n/a	n/a
protective class	I	I
DVC classification	A (Not for use in wet locations)	A (Not for use in wet locations)
electrical overvoltage category	I	I
Rated conditional short-circuit current on input power ports	n/a	n/a
Available output short-circuit current	1mA	1..1.5A
Protective device characteristics	n/a	Internally limited

8 Commissioning and Diagnostics

The following utilities are available for commissioning

- The *TAM System Explorer* software which is used for all commissioning and analysis work flows
- The setup guide [3] and additional documentation on our website.
- The guides for the Beckhoff *TwinCat* Interfaces for *Tria-Link* servo drives [4] and for *EtherCAT* servo drives [5].

8.1 Status Indicators

Immediate state information is available through six bi-colored LEDs on the front side. These indicate the actual state of the drive.

- The *System Status (Sys Status)* indicator shows the overall servo drive state and faults.
- The *STO Status* indicator shows the STO state.
- The *Run Link Status* indicator shows if the fieldbus is running.
- The *Error Link Status* indicator shows if there is a connection error with the fieldbus.
- The two *Axis Status* indicators shows, if the axes are active and have no warning or error.



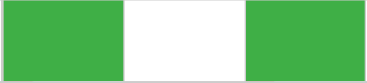

Figure 33: Status indicators

Further information on the status display can be found in the following chapters.

8.1.1 System Status Indicator

The *System Status (Sys Status)* indicator shows the overall status of the servo drive. Errors and warnings from *STO Status and Link Status* are passed to the *System Status* indicator. However, warnings or errors on *Axis Status* are not displayed with this indicator.

The system status indicator can show three different status levels. The following table shows how the status level is related to the signalling of the indicator.

Status Level	Signalling	Description
Normal Operation		Flashing green. No warning or error. However, warning or errors on Axis Status are not displayed here.
Warning		Flashing red. Warning affecting the whole servo drive or warning from other status indicators.
Error		Flashing red. Error affecting the whole servo drive or error from other status indicators.

Warnings on the System Status indicator can have various reasons.



- Warnings indicated from *STO Status*
- Warnings indicated from *Link Status*
- Bridge voltage out of range
- etc.

Errors on the System Status indicator can have various reasons.

- Errors indicated from *STO Status*
- Temperature limit
- etc.

8.1.2 STO Status

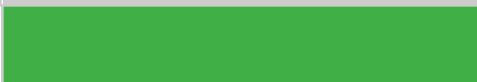
The *STO Status* indicator can show three different status levels. The following table shows how the status level is related to the signalling of the indicator.

Status Level	Signalling	Description
Normal Operation		Steady green. No warning or error.
Warning		Flashing red. <i>STO Active State</i> .
Error		Flashing red. <i>STO Inconsistent, STO Pulse-test failed, other STO related errors.</i>

8.1.3 Run and Error Link Status

The *Run* and *Error Link Status* indicator shows information about the fieldbus status. The signalling of the two fieldbuses is not the same and is described in more detail in the following chapters.

8.1.3.1 *Tria-Link*

If no link is used the servo drive can be configured in stand-alone mode. This has the effect, that both indicators are off. However, if *Tria-Link* is used, the indicators behave as described below.

Run Link Status Indicator

Status Level	Signalling	Description
Normal Operation		Steady green. Link is up and has no errors or warnings.

Error Link Status Indicator



Status Level	Signalling	Description
Error		Steady red. Link is down. Cable is not plugged, etc.

8.1.3.2 *EtherCAT*

The *Run Link* and *Error Link* indicators comply with the official specification of *EtherCAT* Technology Group.

8.1.4 Axis Status Indicator

The two Axis Status indicators shows the state of the two axes. These indicators can show three different status levels. The following table shows how the status level is related to the signalling of the indicator. Note that, errors from *STO Status* and *Sys Status* are passed to this indicator.

Status Level	Signalling	Description
Normal Operation		Steady green. Axis is enabled and in normal operation.
Warning		Flashing red.
Error		Flashing red. Position error, over-current, errors from the other status indicators, etc.

9 Appendix

9.1 Warranty Information

The products covered in this manual are warranted to be free of defects in material and workmanship and conform to the specifications stated either within this document or in the product catalog description. All Triamec Motion AG products are warranted for a period of 12 months from the time of installation, or 18 months from time of shipment, whichever comes first. No other warranties, expressed or implied – and including a warranty of merchantability and fitness for a particular purpose – extend beyond this warranty.

9.2 Service

We are committed to quality customer service. In order to serve in the most effective way, please contact the Customer Support at Triamec Motion AG for assistance.

Triamec Motion AG

Lindenstrasse 16

CH-6340 Baar

Switzerland

Phone: +41-41-747 4040

E-mail: support@triamec.com

Web: www.triamec.com

References

The documents referenced in this manual

- [1] "TP50-TP350 Power Supplies Hardware Manual",
HWTP50-TP350_E_HardwareManual_EP012.pdf, Triamec Motion AG, 2026
- [2] "TPDC50-TPDC130 Power Supplies Hardware Manual",
HWTPDC50-TPDC130_E_HardwareManual_EP003.pdf, Triamec Motion AG, 2026
- [3] "Servo Drive Setup Guide",
ServoDrive-SetupGuide_EP030.pdf, Triamec Motion AG, 2025
- [4] "TwinCAT: Tria-Link Setup Guide",
SWTC_TwinCAT-UserGuide_EP032.pdf, Triamec Motion AG, 2025
- [5] "TwinCAT: EtherCAT Setup Guide",
SWTC_TwinCAT-UserGuideEcat_EP020, Triamec Motion AG, 2026
- [6] "Option Modules Manual",
HWTO_OptionModulesManual_EP020.pdf, Triamec Motion AG, 2024
- [7] "Ethernet Interface",
AN123_Ethernet_EP010.pdf, Triamec Motion AG, 2025
- [8] "Grounding Instructions",
AN144_GroundingInstructions_EP003.pdf, Triamec Motion AG, 2023
- [9] "FieldBus", AN155_FieldBus_EP001.pdf, Triamec Motion AG, 2025

Glossary

Abbrev	Meaning
CE	CE marking
EMC	Electromagnetic compatibility
FET	Field effect transistor
GND	Ground
IEC	International Electrotechnical Commission
ISO	International Organization for Standardization
LED	Light-emitting diode
PELV	Protective Extra Low Voltage
PL	Performance Level
PWM	Pulse-width modulation
RJ-45	Standardized network interface found on Ethernet or network cables
SIL	Safety Integrity Level
STO	Safe torque off
SVM	Space vector modulation
TAM System Explorer	Tool for commissioning, analysis and optimization of a TAM system
TM	Triamec Motion AG
TN-C-S	Terre neutre combiné séparé
TwinCAT	Beckhoff automation software
V _{AC}	AC voltage
V _{DC}	DC voltage
VDE	Verband der Elektrotechnik, Society of German Electrical Technicians

Revision History

Version	Date	Editor	Comment
001	2026-01-23	re, pv	First release for Revision 6, based on manual of HW Revisions 4-5
002	2026-02-09	re	Change of dimension, endoder specification
003	2026-04-15	fm	Fix pin number of digital inputs ground (X30/X31)

Copyright © 2026
Triamec Motion AG
All rights reserved.

Triamec Motion AG
Lindenstrasse 16
6340 Baar / Switzerland

Phone +41 41 747 4040
Email info@triamec.com
Web www.triamec.com

Disclaimer

This document contains proprietary information belonging to Triamec Motion AG and must not be distributed.

This document is delivered subject to the following conditions and restrictions:

- This document contains proprietary information belonging to Triamec Motion AG. Such information is supplied solely for the purpose of assisting users of Triamec products.
- The text and graphics included in this manual are for the purpose of illustration and reference only. The specifications on which they are based are subject to change without notice.
- Information in this document is subject to change without notice.